



YILDIZ
for the best
Polietilen

ÜRÜN KATALOĞU

EN İYİSİ İÇİN - FOR THE BEST - POUR LE MEILLEUR - К ЛУЧШЕМУ - للأفضل

PRODUCT CATALOG - CATALOGUE PRODUITS - ПРОДУКТЫ КАТАЛОГ - كتالوج المنتجات

HDPE EK PARÇA - HDPE FITTINGS - PEHD RACCORDS - HDPE ФИТИНГОВ - ملحقات HDPE

• www.yildizpolietilen.com •

*“Yıldız Bize,
Biz; Su’ya Yön Gösteriyoruz...”*

YILDIZ POLİETİLEN İMALAT İTHALAT İHRACAT SANAYİ LTD. ŞTİ.

*“Yıldız bize, Biz Su’ya yön gösteriyoruz...”
“The stars show us the way, we show way to the water...”*

www.yildizpolietilen.com



YILDIZ POLİETİLEN

2008 yılında sektöre yeni bir soluk olan ve kısa zaman içerisinde hedeflerine ulaşarak adını duyuran YILDIZ POLİETİLEN yaptığı üretimlerle Polietilen Fittings sektöründe emin adımlarla ilerlemektedir.

Yurt içi ve yurt dışına hizmet vermekte olan YILDIZ POLİETİLEN tüm alt yapı ve sulama sistemleri ek parça üretimini bünyesinde barındırmaktadır.

Kırıkkale Organize Sanayi Bölgesinde 15.000 m² alan üzerine inşa edilen 4.000 m² kapalı ve 10.000 m² alan üzerine inşa edilen 3.500 m² kapalı olmak üzere toplamda 25.000 m² alada 7.500 m² kapalı üretim tesisi ile uluslar arası standartlarda ve kalitede üretim yapmaktadır.

Her güne yeni adımlar atarak başlamayı kendine ilke edinmiş olan YILDIZ POLİETİLEN; 32 mm. den 1.600 mm. e kadar Elektrofüzyon Manşon üretim kapasitesini tamamlamış, 2018 yılınında 630 mm. Enjeksiyon üretim kapasitesini, alt yapısını tamamlamak üzere olduğu EF Vanalı Servis Te ve Branşman Semer imalatını hayata geçirmeyi hedeflemektedir.

İlham kaynağını alanında uzman ve deneyimli kadrosundan alan YILDIZ POLİETİLEN Yeni Ankara Merkez Ofisi ile ulaşım ve ticaretine hız katmıştır.

Ürünlerinde ve üretiminde istenilen kaliteye ulaşmış, TSE, WRAS, GOST, ISO 9001, ISO 14001 ve OHSAS uygunluk belgesine sahip, her geçen gün kendisini geliştiren, “Kalite; Üretimin temel esasıdır.” ilkesi ve bilinci ile hareket eden bir Markadır. Yurt içi ve yurt dışına hizmet vermekte olan YILDIZ POLİETİLEN tüm HDPE Polietilen alt yapı ve sulama sistemleri ek parçalarını uluslar arası standartlarda üretmektedir.

YILDIZ POLİETİLEN was established in Ankara to manufacture High Density Polyethylene (HDPE) pipe fittings in 2008.

YILDIZ POLİETİLEN has grown from a local supplying company to a well known international brand. The company manufactures butt fusion fittings, electrofusion fittings, steel flanges and transition fittings at various nominal diameters starting from 20mm up to 1600mm with multiple Nominal Pressure/Standard Dimension Ratios.

YILDIZ POLİETİLEN, a brand that follows technology developments and renews itself continuously, has been leading the market by using the latest technologies and a team of experts in the area and continue to provide a significant amount of products in the construction sector and waterworks. Our brand products are used for huge projects in more than 50 countries in Africa, Asia, Eurasia, Europe, and The Middle East.

All the company's products go through a strict quality control system. A laboratory that covers the entire range of necessary tests has been set up to conduct the tests of the raw materials and fittings. The company has been awarded International certificates such as ISO, OHSAS, GOST and WRAS.

The vision and strategy of YILDIZ POLİETİLEN is to give priority for the demand of the market and our customers. By persistently conducting in-depth analysis of the needs and challenges of the sector, we envisioned to have a structure that can confidently address any question of our customers.

أنشئت شركة يلدز بوليثلين في أنقرة لتصنيع ملحقات الأنابيب البولي ايثيلين عالية الكثافة في عام 2008. نمت يلدز بوليثلين من شركة توريد محلية إلى علامة تجارية دولية معروفة. تقوم الشركة بتصنيع تركيبات الأنابيب البولي ايثيلين عالية الكثافة بأقطار تبدأ من 20 مم وحتى قطر 1600. تعمل شركة يلدز بوليثلين، وهي علامة تجارية تتبع التطورات التكنولوجية وتجدد نفسها باستمرار، في قيادة السوق من خلال استخدام أحدث التقنيات وفريق من الخبراء في المنطقة وتواصل تقديم كمية كبيرة من المنتجات في قطاع الإنشاءات والأشغال المائية. يتم استخدام منتجات علامتنا التجارية للمشاريع الكبيرة في أكثر من 50 دولة في أفريقيا وآسيا وأوروبا والشرق الأوسط. جميع منتجات الشركة تمر عبر نظام صارم لمراقبة الجودة. تم إعداد مختبر يغطي مجموعة كاملة من الاختبارات اللازمة لإجراء اختبارات للمواد الخام والتركيبات. حصلت الشركة على شهادات دولية مثل ISO OHSAS & WRAS تتمثل رؤية واستراتيجيتنا في إعطاء الأولوية لمتطلبات السوق وعملائنا من خلال إجراء تحليل متعمق لاحتياجات وتحديات القطاع.

YILDIZ POLIETILEN a été créée à Ankara pour la fabrication de raccords de tuyauterie en polyéthylène haute densité (PEHD) en 2008.

YILDIZ POLIETILEN est passée d'une entreprise d'approvisionnement locale à une marque internationale réputée. La société fabrique des raccords à bout lisse, des raccords pour l'électro-soudure, des brides en acier et des raccords de différents diamètres nominaux allant de 20 mm à 1600 mm.

YILDIZ POLIETILEN, une marque qui suit les évolutions technologiques et se renouvelle en permanence, domine le marché en utilisant les dernières technologies et une équipe d'experts dans le domaine et continue de fournir une quantité importante de produits dans le secteur de la construction et des installations hydrauliques. Nos produits de marque sont utilisés pour de grands projets dans plus

de 50 pays en Afrique, en Asie, en Eurasie, en Europe et au Moyen-Orient.

Tous les produits de la société sont soumis à un système de contrôle qualité strict. Un laboratoire couvrant toute une gamme d'essais nécessaires a été mis en place pour effectuer des essais sur les matières premières et les raccords. La société a reçu des certificats internationaux tels que ISO, OHSAS, GOST et WRAS.

La vision et la stratégie de YILDIZ POLIETILEN est de hiérarchiser les demandes du marché et de nos clients à travers une analyse en profondeur des besoins et des défis du secteur.

Компания **YILDIZ POLIETILEN** была основана в Анкаре для производства трубных фитингов из полиэтилена высокой плотности (HDPE) в 2008 году.

YILDIZ POLIETILEN вырос из местной компании-поставщика в известный международный бренд. Компания производит фитинги для стыковой сварки, электросварные фитинги, стальные фланцы и переходные фитинги с различными номинальными диаметрами от 20 мм до 1600 мм с несколькими номинальными давлениями / стандартными размерами.

YILDIZ POLIETILEN, бренд, который следит за развитием технологий и постоянно обновляется, лидирует на рынке, используя новейшие технологии и команду экспертов в этой области, и продолжает предоставлять значительный объем продукции в строительном секторе и на водопроводных станциях. Продукция нашего бренда используется для крупных проектов в более чем 50 странах Африки, Азии, Евразии, Европы и Ближнего Востока.

Вся продукция компании проходит строгую систему контроля качества. Для проведения испытаний сырья и фитингов была создана лаборатория, которая охватывает весь спектр необходимых испытаний. Компания была удостоена международных сертификатов, таких как ISO, OHSAS, ГОСТ и WRAS.

Видение и стратегия YILDIZ POLIETILEN состоит в том, чтобы отдавать приоритет потребностям рынка и наших клиентов. Постоянно проводя глубокий анализ потребностей и проблем отрасли, мы предполагали, что у нас будет структура, которая сможет уверенно решать любые вопросы наших клиентов.

"Yıldız bize, Biz Su'ya yön gösteriyoruz..."
"The stars show us the way, we show way to the water..."

www.yildizpolietilen.com



Introduction

YILDIZ POLIETILEN is established in Ivedik Industrial Zone to manufacture HDPE Pipe Fittings in 2008. Our Headquarter is located in ANKARA.

We are a leading manufacturer and exporter of HDPE pipe fittings and acquired an extensive experience in this sector.

YP fittings are manufactured according to the international standards.

Vision and Mission

To give priority for the demand of the market and our customers, client-oriented and to be a leading company in the market.

Quality Policy

YILDIZ POLIETILEN Co. Ltd. is a brand that acts with the consciousness and principle of "Quality is the basis of Production".

Ensuring efficient use of natural resources, providing maximum care and bringing positive value to the environment are our primary and most important policies.

WHY CHOOSE US?

Certified Products

We are proud to be an ISO and WRAS Certified company. We have received **ISO 9001:2008** Certification for Quality Management System, **ISO 14001:2004** Certification for Environmental Management System, **OHSAS 18001:2007** Certification for Occupational Health and Safety Management System and **WRAS** Certificate.



Competitive Prices

Flexible system of discounts for wholesale purchase, discounts for regular customers and the most attentive approach to each client.

Prompt Reply

We address all your questions/inquiries within 24 hours.

Direct from the Manufacturer

Buying directly from the factory ensures you get 100% factory warranty for the entire warranty period. It also makes you get the products with the cheapest price.

No MOQ

We accept low order quantities too.

ÜRÜNLERİMİZ / PRODUCTS PRODUITS / ПРОДУКТЫ / منتجات

ALIN KAYNAK EK PARÇALARI BUTT FUSION FITTINGS

RACCORDS BOUT / ЛИТЫЕ ФИТИНГИ / تركيبات اللحام بعقب

Dirsek, Eşit Te, İnegal Te, Dört Köşe Te, Flanş Adaptörü, Kep ve Redüksiyon Elbows, Equal Tees, Reduced Tees, Cross Tees, Flange Adaptors, Caps, and Reducers.

Coude, Té 90°, Té 90° réduit, Croix, Collet, Bouchon et Réduction

ОТВОД, РАВНОПРОХОДНОЙ ТРОЙНИК, НЕ РАВНОПРОХОДНОЙ ТРОЙНИК, КРЕСТОВИНА, ВТУЛКА ПОД ФЛАНЕЦ, ЗАГЛУШКА а ПЕРЕХОДНИК
كوع تي متساوية تي غير متساوية تي صلبة متساوية برودة سداة تخفيض



Enjeksiyon / Injection

Injectés / Литой / حقن

Dirsek, Eşit Te, İnegal Te, Dört Köşeli Te, Flanş Adaptörü, Kep ve Redüksiyon

Ø20 [mm] den Ø630 [mm] e

Elbows, Equal Tees, Reduced Tees, Cross Tees, Flange Adaptors, Caps, and Reducers...

Coude, Té 90°, Té 90° réduit, Croix, Collet, Bouchon et Réduction

ОТВОД, РАВНОПРОХОДНОЙ ТРОЙНИК, НЕ РАВНОПРОХОДНОЙ ТРОЙНИК, КРЕСТОВИНА, ВТУЛКА ПОД ФЛАНЕЦ, ЗАГЛУШКА а ПЕРЕХОДНИК

كوع تي متساوية تي غير متساوية تي صلبة متساوية برودة سداة تخفيض

Konfeksiyon / Segmented

Segmenté / СВАРНЫЕ / ملفقة

Dirsek, Eşit Te, İnegal Te, Dört Köşe Te, Dört Köşe İnegal Te, Y Çatal Te, Y Çatal İnegal Te

Konfeksiyon ek parça üretiminde Ø1600 [mm] e kadar üretim.

Elbows, Equal Tees, Reduced Tees, Cross Tees, Cross Reduced Tees, Equal Tee Special Degree, Reduced Tee Special Degree...

Coude, Té 90°, Té 90° réduit, Croix,

ОТВОД, РАВНОПРОХОДНОЙ ТРОЙНИК, НЕ РАВНОПРОХОДНОЙ ТРОЙНИК

كوع تي متساوية تي غير متساوية تي صلبة متساوية



ELEKTROFÜZYON MANŞON ELECTROFUSION COUPLERS

MANÇON ES / ЭЛ.СВАРНАЯ МУФТА / وصلة لحام كهربائي

Elektrofüzyon Manşon Üretimimiz Ø32 [mm] - Ø1600 [mm]

"Yıldız bize, Biz Su'ya yön gösteriyoruz..."
"The stars show us the way, we show way to the water..."
www.yildizpolietilen.com

GEÇİŞ ÜRÜNLERİMİZ / TRANSITION FITTINGS RACCORDES DE TRANSITION / ПЕРЕХОДНЫЕ ФИТИНГИ / تركيبات إنتقالية

We produce high quality transition fittings.

Çelik Geçiş Kaynaklı PE - Steel Transition Piece(Welded)

Transition Pe / Acier - ПЭ / СТАЛЬНОЙ ПЕРЕХОДНИК (СВАРНОЙ)

وصلة مرور من البولي إيثيلين / الصلب للحام

Range: 25mm - 1000mm

Çelik Geçiş İç ve Dış Dişli PE Steel Transition Piece (Male/Female Threaded)

Raccord De Transition Pe / Acier (Fileté Mâle / Fileté Femelle)
ПЭ / СТАЛЬНОЙ ПЕРЕХОДНИК (ВНУТРЕННОЙ / С НАРУЖНОЙ) РЕЗЬБОЙ

وصلة مرور من البولي إيثيلين / قلووظ خارجي(داخلي/ خارجي)

Range: 25mm - 160mm

Pirinç Geçiş İç ve Dış Dişli PE - Brass Transition Piece(Male/Female Threaded)

Adaptateur De Transition Pe / Laiton (Fileté Mâle / Fileté Femelle)
ПЭ / ЛАТУННЫЙ ПЕРЕХОДНИК (ВНУТРЕННОЙ / С НАРУЖНОЙ) РЕЗЬБОЙ

وصلة مرور من البولي إيثيلين / النحاس الأصفر قلووظ (داخلي/ خارجي)

Range: 25mm - 110mm



FLANŞLAR / FLANGES BRIDE / ФЛАНЕЦ / فلانشة

We manufacture three types of Flanges



Hdpe Cam Elyaf Takviyeli Kompozit Flanş / HDPE Flange

PEHD Bride / ПЭВП ФЛАНЕЦ / فلانشة

Ø32 [mm] - Ø315 [mm]



PP Kaplı Çelik Flanş / PP Covered Steel Flange:

Bride Acier Revêtue PP / СТАЛЬНОЙ ФЛАНЕЦ С ПП ПОКРЫТИЕМ

فلانشة من الصلب مغطاة بالبولى بروبيلين

Ø32 [mm] - Ø315 [mm]



Paslanmaz Çelik Flanş / Steel Flange:

Bride Acier / СТАЛЬНОЙ ФЛАНЕЦ / فلانشة من الصلب

Ø32 [mm] - Ø1600 [mm]



YILDIZ
For the Best
Polietilen



Turkey
Discover
the potential

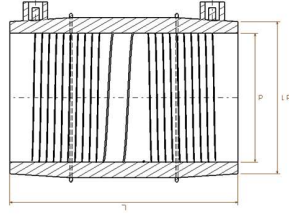

EF MANŞON / EF COUPLER
MANCHON ES / ЭЛ.СВАРНАЯ МУФТА

وصلة لحام كهربائي

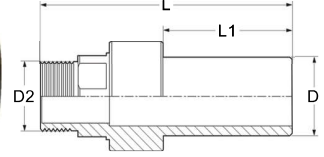
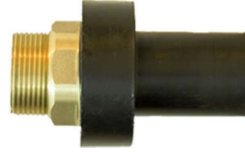

PIRİNÇ GEÇİŞ
PE -BRASS TRANSITION PIECE

ADAPTATEUR DE TRANSITION PE / LAITON

ПЭ / ЛАТУННЫЙ ПЕРЕХОДНИК

وصلة مرور من البولي إيثيلين / النحاس الأصفر قلووظ

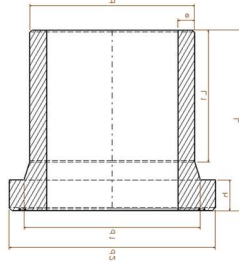

FLANŞ ADAPTÖRÜ
FLANGE ADAPTOR
COLLET / ВТУЛКА ПОД ФЛАНЕЦ / بردة



FLANŞ / FLANGE (PP, PE, ST)
BRIDE / ФЛАНЕЦ / فلانشة

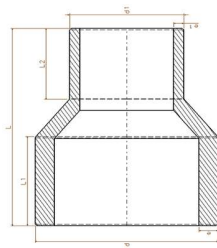

REDÜKSİYON
REDUCER
RÉDUCTION / ПЕРЕХОДНИК / تخفيض

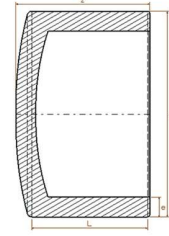

KEP / CAP
СВОУЧОН ИНЖЕСТÉ
ЗАГЛУШКА (Литой) / سداة (حقن)

"Yıldız bize, Biz Su'ya yön gösteriyoruz..."
"The stars show us the way, we show way to the water..."

www.yildizpolietilen.com

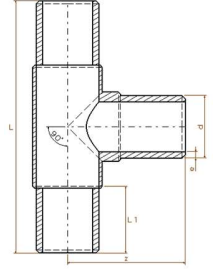
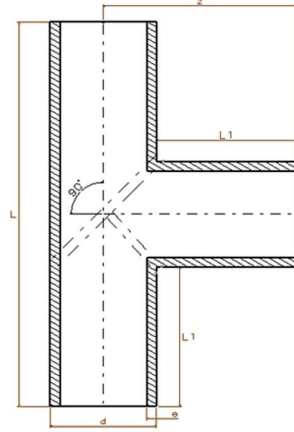

KONFEKSİYON EŞİT TE SEGMENTED EQUAL TEE

TÉ 90° SEGMENTÉ

РАВНОПРОХОДНОЙ ТРОЙНИК 90°

(Сварной)

تي متساوية (ملفقة)

ENJEKSİYON EŞİT TE INJECTION EQUAL TEE

TÉ 90° INJECTÉ

РАВНОПРОХОДНОЙ ТРОЙНИК 90°

(Литой)

تي متساوية (حقن)

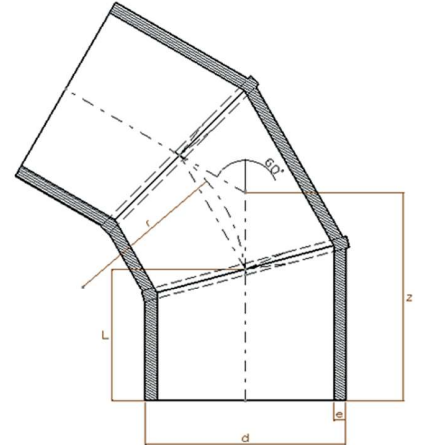
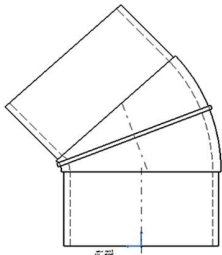

KİT ENJEKSİYON 60° DİRSEK INJECTION ELBOW 60°

COUDE INJECTÉ (KIT) 60°

ОТВОД (приварной литой) 60°

كوع (حقن) 60°

KONFEKSİYON 60° DİRSEK SEGMENTED ELBOW 60°

COUDE SEGMENTÉ 60°

ОТВОД (Сварной) 60° / 60° (ملفقة) كوع

EXPORT
Türkiye'nin
Dünya'da Dört Kıta,
34 Ülkede Tercih edilen Markası;



YILDIZ
for the best
Polietilen

Many organizations/companies across Turkey and around the world use our products to implement huge projects.

Here is the countries where our products have been used so far.

ASIA; Azerbaijan, **Georgia**, Iraq, **Jordan**, Kazakhstan, **Kuwait**, Lebanon, **Qatar**, Saudi Arabia, **South Korea**, Syria, **Turkmenistan**, UAE, **Uzbekistan**

AFRICA; Ethiopia, **Egypt**, Ghana, **Guinea**, Libya, **Liberia**, Mauritius, **Mauritania**, Sudan, **Tunisia**, Uganda

EUROPE; Albania, Bosnia & Herzegovina, **Croatia**, France, **Germany**, Greece, **Iceland**, Ireland, **Italy**, Moldova, **Romania**, Russia, **Poland**, Scotland, **Serbia**, Ukraine

AMERICA; USA

Ø 32 [mm] - Ø1600 [mm]

ELEKTROFÜZYON MANŞON ELECTROFUSION COUPLER

MANCHON ES / ЭЛ.СВАРНАЯ МУФТА / وصلة لحام كهربائي



ELEKTROFÜZYON (EF) MANŞON KAYNAK PROSESİ

Kaynak talimatlarına sırası ile riayet ediniz.

Madde 1 Kaynak yapılacak EF Makine için gerekli şartlar

- 1) Giriş voltaj değeri: **190-240 V.**
- 2) Giriş Frekansı: **50 Hz.**
- 3) Güç kaynağınız
3-1- **7,5 kVA** dan büyük olmalıdır.
3-2- En az **25A** sigorta olmalıdır.
3-3- Güç kaynağınız da topraklı priz olmalıdır.
- 4) Uzatma kablosu kullanıldığında **3x2,5** kesitinde kablo olmalı ve azami **10 mt** yi aşmamalıdır.
- 5) Kaynak makinesi soketi yıpranmış ya da kırık olmamalıdır. Manşon pimi ile soket arasında boşluk, gevşeklik olmamalıdır.

KAYNAK USTASININ EF KAYNAK EĞİTİMİ ALIMIŞ OLMASI GEREKMEKTEDİR!

LÜTFEN KAYNAK PROSEDÜRLERİNE VE ZAMANLARINA UYUNUZ!

HATALI YAPILAN BİR MANŞON KAYNAĞINDA HATANIN DÜZELTİLMESİ 4 KATI ZAMAN VE MALİYETE SEBEP OLACAKTIR!

Madde 2 Kaynak yapılacak malzemeler için gerekli şartlar

- 1) Kaynak yapılacak malzeme ile manşon üzerinde ki SDR-PN değeri (*Küçük çaplarda yaklaşık değer PN16-10*) aynı olmalıdır.
- 2) Kaynak yapılacak malzeme ve borunun toleransı dar olmalıdır.
- 3) HDPE Harici pp, ppr, pvc gibi diğer malzemeler ile kaynak yapılmaz.
- 4) Montaj yapılacak bölgenin sıcaklığı 0° ile 45° C aralığında olmalıdır.
- 5) Boru vb. kaynak yapılacak malzeme kendi eksenine dik açı yapacak şekilde olmalıdır.
- 6) Eğer kesme işlemi yapılacak ise plastik malzeme kesmek için uygun dişleri olan bir testere kullanılabilir.
DİKKAT!
Borunun düzgün bir şekilde kesilmemesi, Manşonda ki metal sargıların belli bölgelerde boruya temas etmemesine neden olur. Bu ise aşırı ısınmaya ve erimiş malzemenin kontrolsüz bir şekilde akmasına yol açabilir.

Madde3 Kaynak sırasında izlenecek yol

- 1) Kaynak alanını belirlenerek borunun veya fittings üzerine işaretlenmelidir. Manşonun ucundan orta noktasına kadar olan mesafe **kaynak alanıdır**.
- 2) Borunun veya fittingsin yüzeyi boru çizgisinin silineceği şekilde talaş oluşuncaya kadar kazınmalıdır. Boru veya fittingsin ucunda talaş kalmamasına dikkat ediniz.
- 3) Yüzeyi kazınmış olan boru veya fittingsin kir, toz, yağ vb olumsuzluklardan arındırınız. Kaynak işlemine başlamadan önce manşonun içini ve borunun yüzeyini temizleme mendili temizleyin.
- 4) Boru veya fittings ile manşonun bağlanması sırasında malzemeler birbirine göre kesinlikle düz olmalıdır. Eğik tutmayın.
- 5) Montaj yapılacak Boru veya fittingsin **oval olmamasına** dikkat ediniz. Ovallık var ise ovallık kelepçesi takarak ovalliği azaltın.
Borunun çap ölçümünü çeşitli noktalardan kontrol ederek ovallik olup olmadığını öğrenebilirsiniz.
- 6) Boru veya fittingsin işaretlenmiş ve temizlenmiş bölgesi manşonun içine rahatlıkla girmelidir. Eğer girmiyorsa tekrar kazıma işlemi yapın.
- 7) Boru veya fittings manşon içine girildikten sonra rahatlıkla döndürülebilir olmalıdır. Kaynak yapılacak malzemelerin kasıntıda olmaması gerekir.
- 8) Eğer EF Manşon ile tamirat yapıyorsanız kaynak yapılacak borudan su gelmediğinden ve ıslak olmadığından emin olunuz. Su sızıntısı kesilmeden ve kurulamadan kaynak yapmayınız. Aksi taktirde kaynak olmayacaktır.
- 9) Manşon kaynak talimatlarına sırası ile riayet edilmiş ve her hangi bir problem oluşmamış ise EF Manşon üzerinde ki kaynak bilgileri manuel olarak yada barkod okuyucu ile EF Kaynak Makinesine girilerek kaynak işlemine başlayabilirsiniz.

Elektrofüzyon manşonların üzerinde kaynak indikatörleri (meme) bulunmaktadır. Kaynak işlemi başladıktan sonra dışarı çıkan bu memeler kaynak işleminin tamamlandığını gösterir. Kaynak işlemi esnasında herhangi bir hata oluşur ise eriyen PE malzeme etrafa sıçrayabilir. **Bu nedenle güvenlik açısından, kaynak işlemi esnasında en az 1 m uzakta durmaya dikkat edin.** Kaynak işlemi herhangi bir nedenle (enerji kesintisi, vb.) kesintiye uğrar ise kaynaklı parçanın soğuması için yeteri kadar beklendikten sonra kaynak işlemine devam edilebilir.

ELECTROFUSION (EF) COUPLER FUSION PROCESS

Follow the fusion instructions in order.

Article 1: Requirements for EF Machine to be fused

- 1) Input Voltage: **190-240 V**
- 2) Input Frequency: **50 Hz.**
- 3) Your Power Source:
 - 3-1- must be greater than **7,5 kVA.**
 - 3-2- must have at least **25A** fuse.
 - 3-3- must have at least **25A** fuse.
- 4) When extension cord is used, the wire gage should be **3x2.5** and it should not exceed **10 m** maximum.
- 5) Processor lead should not be worn or broken. There should be no gap between the Coupler pin and the Processor lead.

PERSONS RESPONSIBLE FOR THE JOINING OF POLYETHYLENE PIPE BY FUSION METHODS MUST HAVE RECEIVED FUSION TRAINING!

PLEASE FOLLOW THE TIME AND PROCEDURES OF THE FUSION CAREFULLY!

TO FIX AN ERROR BEING DONE DURING A COUPLING FUSION WILL COST 4 TIMES MORE TIME AND COSTS!

Article 2 Requirements for materials to be fused

- 1) The SDR-PN value on the Coupler and the material to be fused (Approximate value PN16-10 in small diameters) should be the same.
- 2) The tolerance of the pipe and the material to be fused should be narrow.
- 3) Should not be fused with other non-HDPE materials such as pp, ppr and pvc
- 4) The temperature of the area to be installed should be between 0° and 45°
- 5) The material to be fused like pipe etc. should be perpendicular to its axis.
- 6) If cutting process is to be done, a saw with appropriate teeth can be used to cut the plastic material.

CAUTION:

Improper cutting of the pipe will cause the metal windings in the coupler to not contact the pipe in certain areas. This can lead to overheating and uncontrolled flow of molten material.

Article 3 Procedure to follow during fusion

- 1) Identify the fusion area and mark on the pipe or the fitting.
The fusion area is the distance of the coupler end to the center of the coupler.
- 2) The surface of the pipe or the fitting must be scraped until the pipe line is wiped off. Make sure that the pipe or fitting ends is clean and free of any dirt or chips.
- 3) Remove any dirt, dust, oil etc. from the scraped surface of the pipe or fitting. Before starting fusion process, clean the inside of the coupler and the surface of the pipe with a clean towel.
- 4) When joining pipes or fittings to the couplings, the materials must be absolutely level with respect to each other. Do not hold them oblique.
- 5) Make sure that the pipe or fitting to be installed is not out-of-round. If it is found to be out-of-round, reduce the ovality by attaching the oval clamp.
You can check the diameter of the pipe from various points to find out if there is an out-of-round condition.
- 6) The marked and cleaned area of the pipe or fitting should fit into the coupler easefully. If not, start the scraping process again.
- 7) The pipe or fitting must be easily rotatable after being inserted into the coupler. The materials to be fused must be smooth.
- 8) If you are repairing with EF coupling, make sure that no water comes out of the pipe to be fused and it is not wet. Do not fuse before the water leak is cut and dried. Otherwise, fusion process will not take place.
- 9) If the coupling fusion instructions are followed in order and there are no problems, you can start the fusion process by entering the fusion data on the EF coupling manually or by barcode scanner into the EF welding machine.
- 10) Fusion indicators are located on the electrofusion couplers. These indicators that emerge after starting the fusion process indicates that the fusion process is complete. If any error occurs during the fusion process, the melted PE material may splash around. **Therefore, for safety reasons, be sure to stop at least 1m away during the fusion process.** If the fusion process is interrupted for any reason (power cut, etc.), the fusion process can be resumed after waiting for the welded piece to cool down.

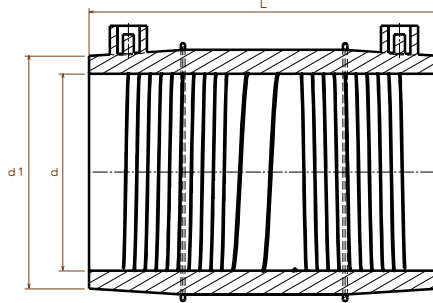

EF MANŞON EF COUPLER

MANÇON ES / ЭЛ.СВАРНАЯ МУФТА / وصلة لحام كهربائي

PE100 - SDR 17 - PN10 ve SDR 11 - PN16

water / gas

SIRA	ÜRÜN KODU	ÇAP d [mm]	BASINÇ [bar]	d _i [mm]	L ₁ [mm]	AĞIRLIK [kg]	KOLİ ADEDİ	KOLİ EBATI
SEQ	PRODUCT CODE	SIZE d [mm]	PRESSURE [bar]			WEIGHT [kg]	PCS / PARCEL	PARCEL SIZE
1	97 6 260025	25	PN16	36,00	71,00	0,05	120	41/60/31
2	97 6 260032	32	PN16	42,00	85,30	0,07	70	24/35/27
3	97 6 260040	40	PN16	53,00	80,00	0,08	100	41/60/31
4	97 6 260050	50	PN16	65,00	87,00	0,13	80	41/60/31
5	97 6 260063	63	PN16	77,62	115,56	0,25	72	41/60/31
6	97 5 260075	75	PN10	90,60	128,10	0,34	56	41/60/31
	PN16							
7	97 5 260090	90	PN10	107,30	138,00	0,58	36	38/50/43
	PN16							
8	97 5 260110	110	PN10	135,00	169,00	0,96	27	43/48/52
	PN16							
9	97 5 260125	125	PN10	152,50	158,50	0,93	16	41/60/31
	PN16							
10	97 5 260140	140	PN10	165,25	176,12	1,02	12	41/60/37
	PN16							
11	97 5 260160	160	PN10	185,90	177,00	1,86	12	41/60/37
	PN16							
12	97 5 260180	180	PN10	216,60	191,00	2,72	12	45/67/40
	PN16							
13	97 5 260200	200	PN10	246,00	214,00	3,60	6	41/60/46
	PN16							
14	97 5 260225	225	PN10	273,50	222,00	4,18	8	50/60/50
	PN16							
15	97 5 260250	250	PN10	309,70	257,80	6,36	8	34/61/52
	PN16							
16	97 5 260280	280	PN10	350,00	233,00	7,60	4	41/60/37
	PN16							

"Yıldız bize, Biz Su'ya yön gösteriyoruz..."
 "The stars show us the way, we show way to the water..."

www.yildizpolietilen.com

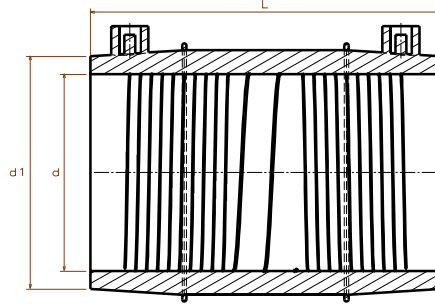

EF MANŞON EF COUPLER

MANÇON ES / ЭЛ.СВАРНАЯ МУФТА / وصلة لحام كهربائي

PE100 - SDR 17 - PN10 ve SDR 11 - PN16

SIRA	ÜRÜN KODU	ÇAP d [mm]	BASINÇ [bar]	d ₁ [mm]	L ₁ [mm]	AĞIRLIK [kg]	KOLİ ADEDİ	KOLİ EBATİ
SEQ	PRODUCT CODE	SIZE d [mm]	PRESSURE [bar]			WEIGHT [kg]	PCS / PARCEL	PARCEL SIZE
17	97 5 260315	315	PN10	371,00	243,55	6,90	2	41/60/37
	97 6 260315		PN16					
18	97 5 260355	355	PN10	392,00	283,85	6,70	2	41/60/46
	97 6 260355		PN16			10,20		
19	97 5 260400	400	PN10	462,00	300,00	8,09	2	50/60/50
	97 6 260400		PN16			12,30		
20	97 5 260450	450	PN10	525,00	338,00	13,73	-	-
	97 6 260450		PN16			20,60		
21	97 5 260500	500	PN10	612,57	365,00	18,22	-	-
	97 6 260500		PN16			27,70		
22	97 5 260560	560	PN10	664,00	360,00	22,40	-	-
	97 6 260560		PN16			33,60		
23	97 5 260630	630	PN10	764,00	344,00	32,70	-	-
	97 6 260630		PN16			49,70		
24	97 5 260710	710	PN10	820,00	380,00	37,90	-	-
	97 6 260710		PN16			69,00		
25	97 5 260800	800	PN10	930,00	400,00	60,00	-	-
	97 6 260800		PN16			88,50		
26	97 5 260900	900	PN10	1080,00	455,00	80,60	-	-
	97 6 260900		PN16			129,30		
27	97 5 261000	1000	PN10	1104,00	485,00	116,40	-	-
	97 6 261000		PN16			174,60		

water / gas

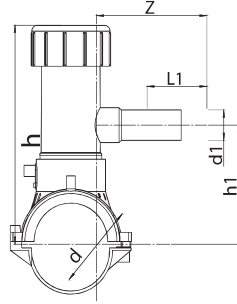

EF VANASIZ SERVİS TE EF TAPPING TEE
PRISE DE BRANCHMENT ES / ЭЛ. СВАРНОЕ СЕДЛО / طوق ربط لحم كهرياني
PE100 - SDR 17 - PN10 ve SDR 11 - PN16

water / gas

SIRA	ÜRÜN KODU	ÇAP d [mm]	BASINÇ [bar]	h [mm]	h ₁ [mm]	L [mm]	L ₁ [mm]	Z [mm]	AĞIRLIK [kg]
SEQ	PRODUCT CODE	SIZE d [mm]	PRESSURE [bar]						WEIGHT [kg]
1	97 9 906320	63/20	PN10	180	97	161	76	129	0,712
	97 9 806320		PN16						
2	97 9 906325	63/25	PN10	180	97	161	75	128	0,716
	97 9 806325		PN16						
3	97 9 906332	63/32	PN10	180	97	161	75	129	0,705
	97 9 806332		PN16						
4	97 9 906340	63/40	PN10	180	97	161	82	136	0,722
	97 9 806340		PN16						
5	97 9 906350	63/50	PN10	227	110	161	100	160	1,024
	97 9 806350		PN16						
6	97 9 906363	63/63	PN10	227	110	161	97	157	1,086
	97 9 806363		PN16						
7	97 9 907520	75/20	PN10	186	104	161	76	129	0,801
	97 9 807520		PN16						
8	97 9 907525	75/25	PN10	186	104	161	75	128	0,795
	97 9 807525		PN16						
9	97 9 907532	75/32	PN10	186	104	161	75	129	0,794
	97 9 807532		PN16						
10	97 9 907540	75/40	PN10	186	104	161	82	136	0,812
	97 9 807540		PN16						
11	97 9 907550	75/50	PN10	233	121	161	100	160	1,113
	97 9 807550		PN16						
12	97 9 907563	75/63	PN10	233	121	161	97	157	1,175
	97 9 807563		PN16						
13	97 9 909020	90/20	PN10	194	112	161	76	129	0,772
	97 9 809020		PN16						
14	97 9 909025	90/25	PN10	194	112	161	75	128	0,765
	97 9 809025		PN16						
15	97 9 909032	90/32	PN10	194	112	161	75	129	0,765
	97 9 809032		PN16						
16	97 9 909040	90/40	PN10	194	112	161	82	136	0,782
	97 9 809040		PN16						
17	97 9 909050	90/50	PN10	241	129	161	100	160	1,084
	97 9 809050		PN16						
18	97 9 909063	90/63	PN10	241	129	161	97	157	1,146
	97 9 809063		PN16						

"Yıldız bize, Biz Su'ya yön gösteriyoruz..."
 "The stars show us the way, we show way to the water..."

www.yildizpolietilen.com



EF VANASIZ SERVİS TE / EF TAPPING TEE / PRISE DE BRANCHMENT ES / ЭЛ. СВАРНОЕ СЕДЛО / طوق ربط لحام كهريائي
 PE100 - SDR17- PN10 ve SDR11 - PN16

SIRA	ÜRÜN KODU	ÇAP d [mm]	BASINÇ [bar]	h [mm]	h ₁ [mm]	L [mm]	L ₁ [mm]	Z [mm]	AĞIRLIK [kg]
SEQ	PRODUCT CODE	SIZE d [mm]	PRESSURE [bar]						WEIGHT [kg]
19	97 9 911020	110/20	PN10	204	122	161	76	129	0,890
	97 9 811020		PN16						
20	97 9 911025	110/25	PN10	204	122	161	75	128	0,884
	97 9 811025		PN16						
21	97 9 911032	110/32	PN10	204	122	161	75	129	0,882
	97 9 811032		PN16						
22	97 9 911040	110/40	PN10	204	122	161	82	136	0,900
	97 9 811040		PN16						
23	97 9 911050	110/50	PN10	251	139	161	100	160	1,201
	97 9 811050		PN16						
24	97 9 911063	110/63	PN10	251	139	161	97	157	1,263
	97 9 811063		PN16						
25	97 9 912520	125/20	PN10	211	129	161	76	129	0,860
	97 9 812520		PN16						
26	97 9 912525	125/25	PN10	211	129	161	75	128	0,854
	97 9 812525		PN16						
27	97 9 912532	125/32	PN10	211	129	161	75	129	0,852
	97 9 812532		PN16						
28	97 9 912540	125/40	PN10	211	129	161	82	136	0,870
	97 9 812540		PN16						
29	97 9 912550	125/50	PN10	258	146	161	100	160	1,171
	97 9 812550		PN16						
30	97 9 912563	125/63	PN10	258	146	161	97	157	1,233
	97 9 812563		PN16						
31	97 9 914020	140/20	PN10	219	137	161	76	129	0,838
	97 9 814020		PN16						
32	97 9 914025	140/25	PN10	219	137	161	75	128	0,834
	97 9 814025		PN16						
33	97 9 914032	140/32	PN10	219	137	161	75	129	0,832
	97 9 814032		PN16						
34	97 9 914040	140/40	PN10	219	137	161	82	136	0,849
	97 9 814040		PN16						
35	97 9 914050	140/50	PN10	266	154	161	100	160	1,150
	97 9 814050		PN16						
36	97 9 914063	140/63	PN10	266	154	161	97	157	1,213
	97 9 814063		PN16						
37	97 9 916020	160/20	PN10	229	147	161	76	129	0,820
	97 9 816020		PN16						
38	97 9 916025	160/25	PN10	229	147	161	75	128	0,814
	97 9 816025		PN16						
39	97 9 916032	160/32	PN10	229	147	161	75	129	0,812
	97 9 816032		PN16						
40	97 9 916040	160/40	PN10	229	147	161	82	136	0,830
	97 9 816040		PN16						
41	97 9 916050	160/50	PN10	276	164	161	100	160	1,131
	97 9 816050		PN16						
42	97 9 916063	160/63	PN10	276	164	161	97	157	1,194
	97 9 816063		PN16						

water / gas

EF VANASIZ SERVİS TE / EF TAPPING TEE / PRISE DE BRANCHMENT ES / ЭЛ. СВАРНОЕ СЕДЛО / طوق ربط لحم كهريائي
PE100 - SDR17- PN10 ve SDR11 - PN16

SIRA	ÜRÜN KODU	ÇAP d [mm]	BASINÇ [bar]	h [mm]	h ₁ [mm]	L [mm]	L ₁ [mm]	Z [mm]	AĞIRLIK [kg]
SEQ	PRODUCT CODE	SIZE d [mm]	PRESSURE [bar]						WEIGHT [kg]
43	97 9 918020	180/20	PN10	239	157	162	76	129	0,958
	97 9 818020		PN16						
44	97 9 918025	180/25	PN10	239	157	162	75	128	0,953
	97 9 818025		PN16						
45	97 9 918032	180/32	PN10	239	157	162	75	129	0,952
	97 9 818032		PN16						
46	97 9 918040	180/40	PN10	239	157	162	82	136	0,968
	97 9 818040		PN16						
47	97 9 918050	180/50	PN10	286	174	162	100	160	1,270
	97 9 818050		PN16						
48	97 9 918063	180/63	PN10	286	174	162	97	157	1,332
	97 9 818063		PN16						
49	97 9 920020	200/20	PN10	249	168	162	76	129	0,947
	97 9 820020		PN16						
50	97 9 920025	200/25	PN10	249	168	162	75	128	0,942
	97 9 820025		PN16						
51	97 9 920032	200/32	PN10	249	168	162	75	129	0,940
	97 9 820032		PN16						
52	97 9 920040	200/40	PN10	249	168	162	82	136	0,958
	97 9 820040		PN16						
53	97 9 920050	200/50	PN10	296	184	162	100	160	1,260
	97 9 820050		PN16						
54	97 9 920063	200/63	PN10	296	184	162	97	157	1,322
	97 9 820063		PN16						
55	97 9 922520	225/20	PN10	261	179	162	76	129	0,957
	97 9 822520		PN16						
56	97 9 922525	225/25	PN10	261	179	162	75	128	0,952
	97 9 822525		PN16						
57	97 9 922532	225/32	PN10	261	179	162	75	129	0,952
	97 9 822532		PN16						
58	97 9 922540	225/40	PN10	261	179	162	82	136	0,970
	97 9 822540		PN16						
59	97 9 922550	225/50	PN10	308	196	162	100	160	1,271
	97 9 822550		PN16						
60	97 9 922563	225/63	PN10	308	196	162	97	157	1,332
	97 9 822563		PN16						
61	97 9 925020	250/20	PN10	274	192	162	76	129	0,981
	97 9 825020		PN16						
62	97 9 925025	250/25	PN10	274	192	162	75	128	0,974
	97 9 825025		PN16						
63	97 9 925032	250/32	PN10	274	192	162	75	129	0,973
	97 9 825032		PN16						
64	97 9 925040	250/40	PN10	274	192	162	82	136	0,990
	97 9 825040		PN16						
65	97 9 925050	250/50	PN10	321	209	162	100	160	1,291
	97 9 825050		PN16						
66	97 9 925063	250/63	PN10	321	209	162	97	157	1,353
	97 9 825063		PN16						

water / gas

"Yıldız bize, Biz Su'ya yön gösteriyoruz..."
 "The stars show us the way, we show way to the water..."

www.yildizpolietilen.com



EF VANASIZ SERVİS TE / EF TAPPING TEE / PRISE DE BRANCHMENT ES / ЭЛ. СВЯРНОЕ СЕДЛО / طوق ربط لحام كهربائی
 PE100 - SDR17- PN10 ve SDR11 - PN16

SIRA	ÜRÜN KODU	ÇAP d [mm]	BASINÇ [bar]	h [mm]	h ₁ [mm]	L [mm]	L ₁ [mm]	Z [mm]	AĞIRLIK [kg]
SEQ	PRODUCT CODE	SIZE d [mm]	PRESSURE [bar]						WEIGHT [kg]
67	97 9 928020	280/20	PN10	289	207	162	76	129	1,024
	97 9 828020		PN16						
68	97 9 928025	280/25	PN10	289	207	162	75	128	1,016
	97 9 828025		PN16						
69	97 9 928032	280/32	PN10	289	207	162	75	129	1,017
	97 9 828032		PN16						
70	97 9 928040	280/40	PN10	289	207	162	82	136	1,034
	97 9 828040		PN16						
71	97 9 928050	280/50	PN10	336	224	162	100	160	1,336
	97 9 828050		PN16						
72	97 9 928063	280/63	PN10	336	224	162	97	157	1,398
	97 9 828063		PN16						
73	97 9 931520	315/20	PN10	306	224	162	76	129	1,051
	97 9 831520		PN16						
74	97 9 931525	315/25	PN10	306	224	162	75	128	1,045
	97 9 831525		PN16						
75	97 9 931532	315/32	PN10	306	224	162	75	129	1,044
	97 9 831532		PN16						
76	97 9 931540	315/40	PN10	306	224	162	82	136	1,061
	97 9 831540		PN16						
77	97 9 931550	315/50	PN10	353	241	162	100	160	1,363
	97 9 831550		PN16						
78	97 9 931563	315/63	PN10	353	241	162	97	157	1,425
	97 9 831563		PN16						
79	97 9 935520	355/20	PN10	326	244	162	76	129	1,124
	97 9 835520		PN16						
80	97 9 935525	355/25	PN10	326	244	162	75	128	1,118
	97 9 835525		PN16						
81	97 9 935532	355/32	PN10	326	244	162	75	129	1,116
	97 9 835532		PN16						
82	97 9 935540	355/40	PN10	326	224	162	82	136	1,134
	97 9 835540		PN16						
83	97 9 935550	355/50	PN10	373	261	162	100	160	1,435
	97 9 835550		PN16						
84	97 9 935563	355/63	PN10	373	261	162	97	157	1,497
	97 9 835563		PN16						
85	97 9 940020	400/20	PN10	349	267	162	76	129	1,206
	97 9 840020		PN16						
86	97 9 940025	400/25	PN10	349	267	162	75	128	1,201
	97 9 840025		PN16						
87	97 9 940032	400/32	PN10	349	267	162	75	129	1,198
	97 9 840032		PN16						
88	97 9 940040	400/40	PN10	349	267	162	82	136	1,216
	97 9 840040		PN16						
89	97 9 940050	400/50	PN10	396	284	162	100	160	1,518
	97 9 840050		PN16						
90	97 9 940063	400/63	PN10	396	284	162	97	157	1,579
	97 9 840063		PN16						

water / gas



YILDIZ
for the best
Polietilen

Ø 32 [mm] - Ø1600 [mm]

FLANŞ ADAPTÖRÜ

FLANGE ADAPTER

COLLET / ВТУЛКА ПОД ФЛАНЕЦ / بردة



"Yıldız bize, Biz Su'ya yön gösteriyoruz..."
 "The stars show us the way, we show way to the water..."

www.yildizpolietilen.com

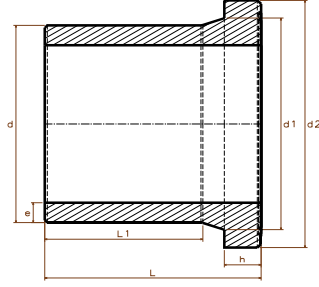

ENJEKSİYON FLANŞ ADAPTÖRÜ (UZUN TİP)
 INJECTION FLANGE ADAPTER (LONG TYPE)

COLLET LONG INJECTÉ / ВТУЛКА ПОД ФЛАНЕЦ ДЛИННЫЙ ТИП (Литой) / برده طویلہ (حقن)
 PE100 - SDR 17 - PN10 ve SDR 11 - PN16

SIRA	ÜRÜN KODU	ÇAP d [mm]	BASINÇ [bar]	L [mm]	L ₁ [mm]	h [mm]	d ₁ [mm]	d ₂ [mm]	e [mm]	AĞIRLIK [kg]	KOLİ ADEDİ	KOLİ EBATI
SEQ.	PRODUCT CODE	SIZE d [mm]	PRESSURE [bar]							WEIGHT [kg]	PCS PARCEL	PARCEL SIZE
1	97 1 551102	25	PN16	88,40	62,55	11,10	31,64	59,75	2,70	0,04	250	30/60/41
2	97 2 551103	32	PN10	85,20	57,40	10,80	39,75	67,70	2,30	0,04	200	30/60/41
	PN16		3,20						0,06			
3	97 1 551104	40	PN10	84,86	58,00	13,30	46,55	74,60	2,80	0,05	160	30/60/41
	PN16		4,04						0,08			
4	97 1 551105	50	PN10	85,68	52,40	16,14	56,25	82,53	3,40	0,08	120	30/60/41
	PN16		5,00						0,12			
5	97 1 551106	63	PN10	106,00	68,00	16,00	70,70	100,00	4,00	0,13	70	30/60/41
	PN16		6,50						0,19			
6	97 1 551107	75	PN10	107,30	77,64	20,70	89,30	117,95	4,80	0,19	50	30/60/41
	PN16		7,60						0,29			
7	97 1 551109	90	PN10	123,60	92,00	20,33	106,00	136,40	5,70	0,30	30	30/60/41
	PN16		9,20						0,45			
8	97 1 551111	110	PN10	136,90	94,00	19,00	123,00	153,10	7,40	0,51	24	30/60/41
	PN16		11,10						0,61			
9	97 1 551112	125	PN10	149,00	117,00	26,24	136,00	155,50	8,09	0,51	20	30/60/41
	PN16		12,50						0,76			
10	97 1 551114	140	PN10	137,70	94,00	26,30	143,50	184,90	9,00	0,68	20	41/60/46
	PN16		14,10						1,02			
11	97 1 551116	160	PN10	175,26	127,30	29,80	171,50	211,50	10,60	1,29	12	41/60/46
	PN16		16,20						1,58			
12	97 1 551118	180	PN10	136,90	165,95	28,60	191,12	213,00	11,23	1,11	12	41/60/46
	PN16		17,35						1,66			
13	97 1 551120	200	PN10	194,00	140,30	33,00	218,20	264,20	16,00	2,50	12	41/60/46
	PN16		18,70						2,73			
14	97 1 551122	225	PN10	188,10	138,10	36,80	234,00	268,00	14,40	2,38	12	41/60/46
	PN16		21,20						3,04			
15	97 1 551125	250	PN10	192,22	136,20	34,60	272,00	320,00	15,70	3,20	8	41/60/46
	PN16		24,80						4,18			
16	97 1 551128	280	PN10	181,20	132,10	36,70	287,00	319,00	18,20	3,30	8	41/60/46
	PN16		26,23						4,25			
17	97 1 551131	315	PN10	201,60	147,70	40,70	330,00	370,00	20,70	5,11	3	41/60/46
	PN16		24,80						6,43			
18	97 1 551135	355	PN10	212,40	149,80	46,55	368,00	418,00	21,51	5,73	2	41/60/46
	PN16		33,25						8,60			

water / gas

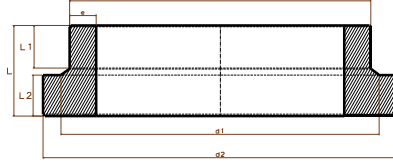

ENJEKSİYON FLANŞ ADAPTÖRÜ (KISA TİP)
INJECTION FLANGE ADAPTER (SHORT TYPE)

بردة قصيرة (حقن) / Втулка под фланец короткий тип (Литой) / COLLET COURT INJECTÉ / ВТУЛКА ПОД ФЛАНЕЦ КОРОТКИЙ ТИП (Литой)

PE100 - SDR 17 - PN10 ve SDR 11 - PN16

water / gas

SIRA	ÜRÜN KODU	ÇAP d [mm]	BASINÇ [bar]	L [mm]	L ₁ [mm]	h [mm]	d ₁ [mm]	d ₂ [mm]	e [mm]	AĞIRLIK [kg]	KOLİ ADEDİ	KOLİ EBATI
SEQ.	PRODUCT CODE	SIZE d [mm]	PRESSURE [bar]	L [mm]	L ₁ [mm]	h [mm]	d ₁ [mm]	d ₂ [mm]	e [mm]	WEIGHT [kg]	IN A PARCEL	PARCEL SIZE
1	97 1 550031	315	PN10	112,00	67,00	33,60	330,00	368,00	20,00	2,92	6	41/60/46
	97 2 550031		PN16						30,00	4,38		
2	97 1 550035	355	PN10	114,85	60,46	35,16	366,00	416,00	21,50	4,00	5	41/60/46
	97 2 550035		PN16						32,75	4,80		
3	97 1 550040	400	PN10	174,65	105,44	47,90	410,00	480,00	26,20	7,80	3	50/60/50
	97 2 550040		PN16						39,00	9,70		
4	97 1 550045	450	PN10	200,80	103,54	64,50	460,50	498,00	29,20	9,70	2	50/60/50
	97 2 550045		PN16						45,10	14,55		
5	98 1 550050	500	PN10	150,00	71,50	68,00	528,00	588,00	30,60	10,60	-	-
	98 2 550050		PN16						45,50	13,90		
6	98 1 550056	560	PN10	196,50	113,30	61,04	615,00	675,00	33,78	18,50	-	-
	98 2 550056		PN16						52,20	22,00		
7	99 1 550063	630	PN10	208,15	138,20	61,44	650,00	675,00	40,00	16,60	-	-
	99 2 550063		PN16						57,20	21,40		
8	98 1 550071	710	PN10	150,00	60,00	70,00	737,00	785,00	44,00	19,00	-	-
	98 2 550071		PN16						68,60	25,20		
9	98 1 550080	800	PN10	150,00	70,00	55,00	840,00	910,00	50,00	23,97	-	-
	98 2 550080		PN16						74,20	32,11		
10	98 1 550090	900	PN10	155,00	60,00	55,00	985,00	1010,00	55,00	31,51	-	-
	98 2 550090		PN16						86,50	42,08		
11	98 1 550100	1000	PN10	150,00	70,00	55,00	1047,00	1120,00	62,50	35,46	-	-
	98 2 550100		PN16						99,10	45,41		
12	98 1 550120	1200	PN10	150,00	70,00	60,00	1245,00	1330,00	74,50	44,90	-	-
13	98 1 550140	1400	PN10	200,00	85,00	75,00	1450,00	1535,00	87,20	77,53	-	-
14	98 1 550160	1600	PN10	200,00	80,00	80,00	1645,00	1737,00	102,10	98,97	-	-



YILDIZ
for the best
Polietilen

Ø 32 [mm] - Ø1600 [mm]

DİRSEK - ELBOW

COUDE / ОТВОД / كوع

90° - 60° - 45° - 30° - 22° - 11°



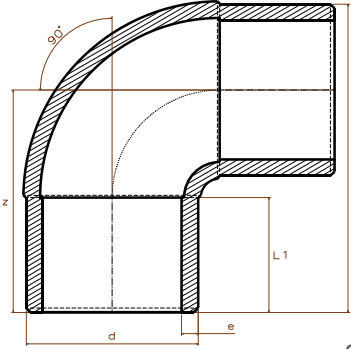

ENJEKSİYON 90 ° DİRSEK
INJECTION 90 ° ELBOW

COUDE INJECTÉ 90° / ОТВОД (Литой) 90° / 90° كوع (حقن)
PE100 - SDR 17 - PN10 ve SDR 11 - PN16

water / gas

SIRA	ÜRÜN KODU	ÇAP d [mm]	BASINÇ [bar]	L [mm]	z [mm]	L ₁ [mm]	e [mm]	AĞIRLIK [kg]	KOLİ ADEDİ	KOLİ EBATI
SEQ.	PRODUCT CODE	SIZE d [mm]	PRESSURE [bar]	L [mm]	z [mm]	L ₁ [mm]	e [mm]	WEIGHT [kg]	IN A PARCEL	PARCEL SIZE
1	97 0 101003	32	PN10	69,40	53,40	28,50	2,30	0,02	200	30/60/41
	97 1 101003		PN16				3,20	0,03		
2	97 0 101004	40	PN10	106,00	86,00	49,00	2,80	0,08	70	30/60/41
	97 1 101004		PN16				4,05	0,12		
3	97 0 101005	50	PN10	128,00	103,00	61,20	3,40	0,11	65	30/60/41
	97 1 101005		PN16				4,65	0,17		
4	97 0 101006	63	PN10	147,00	115,50	62,80	3,80	0,22	52	30/60/41
	97 1 101006		PN16				6,50	0,33		
5	97 0 101007	75	PN10	167,00	129,50	66,10	4,50	0,29	40	30/60/41
	97 1 101007		PN16				7,40	0,44		
6	97 0 101009	90	PN10	202,00	157,00	85,60	5,40	0,51	24	30/60/41
	97 1 101009		PN16				8,60	0,77		
7	97 0 101011	110	PN10	210,00	155,00	82,40	6,70	0,96	20	41/60/46
	97 1 101011		PN16				10,10	1,06		
8	97 0 101012	125	PN10	240,00	177,50	94,00	7,50	1,04	10	30/60/41
	97 1 101012		PN16				12,50	1,56		
9	97 0 101014	140	PN10	250,00	180,00	95,90	8,80	1,31	12	41/60/46
	97 1 101014		PN16				14,10	1,97		
10	97 0 101016	160	PN10	292,53	210,00	108,00	10,15	2,10	8	41/60/46
	97 1 101016		PN16				15,40	2,76		
11	97 0 101018	180	PN10	310,00	220,00	108,80	11,70	2,47	6	41/60/46
	97 1 101018		PN16				16,60	3,71		
12	97 0 101020	200	PN10	347,00	247,00	121,00	12,10	3,55	4	41/60/46
	97 1 101020		PN16				19,42	5,33		
13	97 0 101022	225	PN10	378,00	265,00	124,00	14,00	4,32	6	50/60/50
	97 1 101022		PN16				21,60	6,48		
14	97 0 101025	250	PN10	400,00	275,00	127,00	15,40	5,57	4	50/60/50
	97 1 101025		PN16				22,80	8,35		
15	97 0 101028	280	PN10	435,17	295,17	120,00	17,00	7,24	1	50/60/50
	97 1 101028		PN16				26,00	10,86		
16	97 0 101031	315	PN10	505,00	347,50	151,70	20,40	12,90	1	50/60/50
	97 1 101031		PN16				30,00	19,35		

"Yıldız bize, Biz Su'ya yön gösteriyoruz..."
 "The stars show us the way, we show way to the water..."

www.yildizpolietilen.com

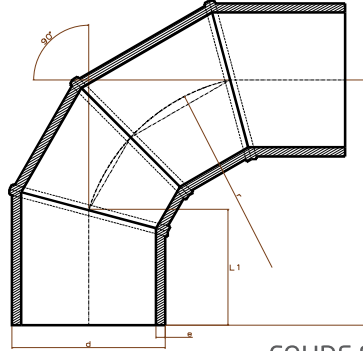

KONFEKSİYON 90 ° DİRSEK
 SEGMENTED 90 ° ELBOW

COUDE SEGMENTÉ 90° / ОТВОД (Сварной) 90° / 90° (مرفقة) كوع
 PE100 - SDR 17 - PN10 ve SDR 11 - PN16

SIRA	ÜRÜN KODU	ÇAP d [mm]	BASINÇ [bar]	L [mm]	z [mm]	L ₁ [mm]	e [mm]	AĞIRLIK [kg]	KOLİ ADEDİ	KOLİ EBATI
SEQ	PRODUCT CODE	SIZE d [mm]	PRESSURE [bar]					WEIGHT [kg]	IN A PARCEL	PARCEL SIZE
1	97 9 170250	250	PN10	200,00	473,21	386,37	14,80	11,84	-	-
	97 0 170250		PN16				22,70	18,16		
2	97 9 170280	280	PN10	220,00	520,53	425,00	16,60	14,61	-	-
	97 0 170280		PN16				25,40	22,35		
3	97 9 170315	315	PN10	225,00	532,36	434,66	18,70	16,83	-	-
	97 0 170315		PN16				28,60	25,74		
4	97 9 170355	355	PN10	240,00	567,85	463,64	21,10	20,26	-	-
	97 0 170355		PN16				32,20	30,91		
5	97 9 170400	400	PN10	250,00	591,51	482,96	23,70	23,70	-	-
	97 0 170400		PN16				36,30	36,30		
6	97 9 170450	450	PN10	265,00	627,00	511,93	26,70	28,30	-	-
	97 0 170450		PN16				40,90	43,35		
7	97 9 170500	500	PN10	287,50	680,23	555,40	29,70	34,16	-	-
	97 0 170500		PN16				45,40	52,21		
8	97 9 170560	560	PN10	310,00	733,47	598,87	33,20	41,17	-	-
	97 0 170560		PN16				50,80	62,99		
9	97 9 170630	630	PN10	355,00	839,94	685,80	37,40	53,11	-	-
	97 0 170630		PN16				57,20	81,22		
10	97 9 170710	710	PN10	375,00	887,26	724,43	42,10	63,15	-	-
	97 0 170710		PN16				64,50	96,75		
11	97 9 170800	800	PN10	405,00	958,24	782,39	47,40	76,79	-	-
	97 0 170800		PN16				72,80	117,94		
12	97 9 170900	900	PN10	425,00	1005,56	821,03	53,30	90,61	-	-
	97 0 170900		PN16				81,70	138,89		
13	97 9 171000	1000	PN10	450,00	1064,71	869,32	59,30	106,74	-	-
	97 0 171000		PN16				90,80	163,44		
14	97 9 171200	1200	PN10	575,00	1360,46	1110,80	70,60	162,38	-	-
	97 0 171200		PN16				-	-		
15	97 9 171400	1400	PN10	675,00	1597,07	1303,98	83,00	224,10	-	-
	97 0 171400		PN16				-	-		
16	97 9 171600	1600	PN10	800,00	1892,82	1545,46	94,80	303,36	-	-
	97 0 171600		PN16				-	-		

water / gas

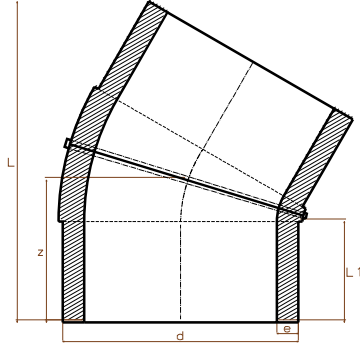

KİT ENJEKSİYON KAYNAKLI 60° DİRSEK
KIT INJECTION WELDED 60° ELBOW

COUDE INJECTÉ (KIT) 60° / ОТВОД (приварной литой) 60° / 60° (كوع حقن)

PE100 - SDR 17 - PN10 ve SDR 11 - PN16

water / gas

SIRA	ÜRÜN KODU	ÇAP d [mm]	BASINÇ [bar]	L [mm]	z [mm]	L ₁ [mm]	e [mm]	AĞIRLIK [kg]	KOLİ ADEDİ	KOLİ EBATLARI
SEQ.	PRODUCT CODE	SIZE d [mm]	PRESSURE [bar]					WEIGHT [kg]	IN A PARCEL	PARCEL SIZE
1	97 0 201009	90	PN10	217,93	104,73	85,60	5,40	0,31	28	30/60/41
	97 1 201009		PN16				8,60	0,45		
2	97 0 201011	110	PN10	217,56	101,85	82,40	6,70	0,45	22	41/60/46
	97 1 201011		PN16				10,10	0,65		
3	97 0 201012	125	PN10	248,41	116,37	94,00	7,50	0,65	18	41/60/46
	97 1 201012		PN16				12,50	0,97		
4	97 0 201014	140	PN10	256,00	118,43	95,90	8,80	0,83	14	41/60/46
	97 1 201014		PN16				14,10	1,23		
5	97 0 201016	160	PN10	292,53	135,33	108,00	10,15	1,25	8	41/60/46
	97 1 201016		PN16				15,40	1,84		
6	97 0 201018	180	PN10	303,63	138,60	108,80	11,70	1,62	6	41/60/46
	97 1 201018		PN16				16,60	2,38		
7	97 0 201020	200	PN10	338,79	154,76	121,00	12,10	2,23	6	41/60/46
	97 1 201020		PN16				19,42	3,28		
8	97 0 201022	225	PN10	358,14	161,78	124,00	14,00	2,95	6	50/60/50
	97 1 201022		PN16				21,60	4,33		
9	97 0 201025	250	PN10	373,49	166,66	127,00	15,40	3,75	4	50/60/50
	97 1 201025		PN16				22,80	5,53		
10	97 0 201028	280	PN10	381,51	165,34	120,00	16,70	4,65	1	50/60/50
	97 1 201028		PN16				25,50	6,89		
11	97 0 201031	315	PN10	459,73	204,16	151,70	20,40	7,28	1	50/60/50
	97 1 201031		PN16				30,00	10,71		

"Yıldız bize, Biz Su'ya yön gösteriyoruz..."
 "The stars show us the way, we show way to the water..."

www.yildizpolietilen.com

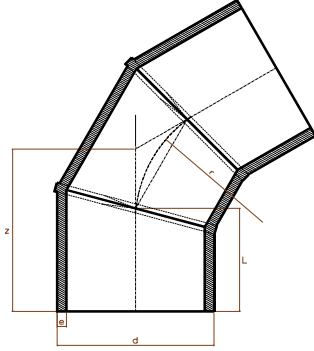

KONFEKSİYON 60 ° DİRSEK
 SEGMENTED 60 ° ELBOW
 COUDE SEGMENTÉ 60° / ОТВОД (Сварной) 60° / 60° (مملفة)
 PE100 - SDR 17 - PN10 ve SDR 11 - PN16

SIRA	ÜRÜN KODU	ÇAP d [mm]	BASINÇ [bar]	L [mm]	z [mm]	r [mm]	e [mm]	AĞIRLIK [kg]	KOLİ ADEDİ	KOLİ EBATI
SEQ	PRODUCT CODE	SIZE d [mm]	PRESSURE [bar]					WEIGHT [kg]	IN A PARCEL	PARCEL SIZE
1	97 9 160250	250	PN10	185,00	291,81	185,00	14,80	8,21	-	-
	97 0 160250		PN16				22,70	12,60	-	-
2	97 9 160280	280	PN10	200,00	315,47	200,00	16,60	9,96	-	-
	97 0 160280		PN16				25,40	15,24	-	-
3	97 9 160315	315	PN10	210,00	331,24	210,00	18,70	11,78	-	-
	97 0 160315		PN16				28,60	18,02	-	-
4	97 9 160355	355	PN10	233,00	367,52	233,00	21,10	14,75	-	-
	97 0 160355		PN16				32,20	22,51	-	-
5	97 9 160400	400	PN10	247,00	389,61	247,00	23,70	17,56	-	-
	97 0 160400		PN16				36,30	26,90	-	-
6	97 9 160450	450	PN10	260,00	410,11	260,00	26,70	20,83	-	-
	97 0 160450		PN16				40,90	31,90	-	-
7	97 9 160500	500	PN10	273,00	430,62	273,00	29,70	24,32	-	-
	97 0 160500		PN16				45,40	37,18	-	-
8	97 9 160560	560	PN10	287,00	452,70	287,00	33,20	28,59	-	-
	97 0 160560		PN16				50,80	43,74	-	-
9	97 9 160630	630	PN10	320,00	504,75	320,00	37,40	35,90	-	-
	97 0 160630		PN16				57,20	54,91	-	-
10	97 9 160710	710	PN10	368,00	580,46	368,00	42,10	46,48	-	-
	97 0 160710		PN16				64,50	71,21	-	-
11	97 9 160800	800	PN10	383,00	604,13	383,00	47,40	54,46	-	-
	97 0 160800		PN16				72,80	83,65	-	-
12	97 9 160900	900	PN10	433,00	683,00	433,00	53,30	69,24	-	-
	97 0 160900		PN16				81,70	106,13	-	-
13	97 9 161000	1000	PN10	450,00	709,80	450,00	59,30	80,06	-	-
	97 0 161000		PN16				90,80	122,58	-	-
14	97 9 161200	1200	PN10	500,00	788,68	500,00	70,60	105,90	-	-
	97 0 161200		PN16				-	-	-	-
15	97 9 161400	1400	PN10	633,00	998,46	633,00	83,00	157,62	-	-
	97 0 161400		PN16				-	-	-	-
16	97 9 161600	1600	PN10	733,00	1156,20	733,00	94,80	208,47	-	-
	97 0 161600		PN16				-	-	-	-

water / gas

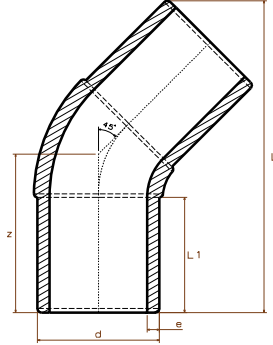

ENJEKSİYON 45 ° DİRSEK
INJECTION 45 ° ELBOW
COUDE INJECTÉ 45° / ОТВОД (Литой) 45° / 45° كوع (حقن)
PE100 - SDR 17 - PN10 ve SDR 11 - PN16

water / gas

SIRA	ÜRÜN KODU	ÇAP d [mm]	BASINÇ [bar]	L [mm]	z [mm]	L ₁ [mm]	e [mm]	AĞIRLIK [kg]	KOLİ ADEDİ	KOLİ EBATI
SEQ.	PRODUCT CODE	SIZE d [mm]	PRESSURE [bar]					WEIGHT [kg]	IN A PARCEL	PARCEL SIZE
1	97 0 984503	32	PN10	102,37	53,34	40,40	2,30	0,03	220	30/60/41
	97 1 984503		PN16				3,10	0,05		
2	97 0 984504	40	PN10	132,85	69,54	50,10	2,80	0,05	80	30/60/41
	97 1 984504		PN16				3,80	0,08		
3	97 0 984505	50	PN10	152,30	78,86	58,00	3,40	0,09	65	30/60/41
	97 1 984505		PN16				5,15	0,14		
4	97 0 984506	63	PN10	188,30	97,26	68,60	4,30	0,15	60	30/60/41
	97 1 984506		PN16				5,80	0,23		
5	97 0 984507	75	PN10	190,00	95,77	70,00	4,80	0,19	40	30/60/41
	97 1 984507		PN16				6,80	0,29		
6	97 0 984509	90	PN10	226,00	113,75	83,00	5,50	0,33	28	30/60/41
	97 1 984509		PN16				8,45	0,50		
7	97 0 984511	110	PN10	255,00	126,59	84,00	6,80	0,55	22	41/60/46
	97 1 984511		PN16				10,10	0,82		
8	97 0 984512	125	PN10	265,00	129,35	87,00	7,60	0,77	18	41/60/46
	97 1 984512		PN16				11,70	1,15		
9	97 0 984514	140	PN10	294,00	143,23	95,20	8,40	0,99	14	41/60/46
	97 1 984514		PN16				12,80	1,48		
10	97 0 984516	160	PN10	330,00	160,17	105,00	9,50	1,47	8	41/60/46
	97 1 984516		PN16				14,70	2,20		
11	97 0 984518	180	PN10	345,00	164,82	110,00	11,25	2,00	6	41/60/46
	97 1 984518		PN16				17,40	3,00		
12	97 0 984520	200	PN10	380,00	181,18	117,00	12,30	2,80	6	41/60/46
	97 1 984520		PN16				19,00	4,00		
13	97 0 984522	225	PN10	400,00	187,72	123,00	14,00	3,40	6	50/60/50
	97 1 984522		PN16				21,00	5,10		
14	97 0 984525	250	PN10	443,00	207,73	133,76	16,20	4,80	4	50/60/50
	97 1 984525		PN16				25,00	7,20		

"Yıldız bize, Biz Su'ya yön gösteriyoruz..."
"The stars show us the way, we show way to the water..."
www.yildizpolietilen.com

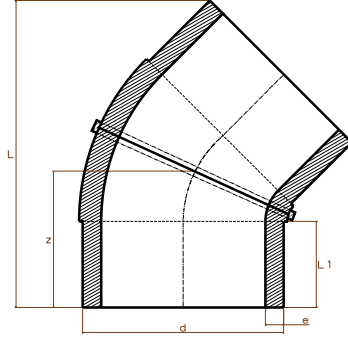

KİT ENJEKSİYON KAYNAKLI 45 ° DİRSEK
KIT INJECTION WELDED 45 ° ELBOW
COUDE INJECTÉ (KIT) 45° / ОТВОД (приварной литой) 45° / 45° (كوع حقن)
PE100 - SDR 17 - PN10 ve SDR 11 - PN16

SIRA	ÜRÜN KODU	ÇAP d [mm]	BASINÇ [bar]	L [mm]	z [mm]	L ₁ [mm]	e [mm]	AĞIRLIK [kg]	KOLİ ADEDİ	KOLİ EBATI
SEQ.	PRODUCT CODE	SIZE d [mm]	PRESSURE [bar]					WEIGHT [kg]	IN A PARCEL	PARCEL SIZE
1	97 0 985528	280	PN10	427,71	187,03	120,00	16,70	5,25	1	50/60/50
	PN16		25,50				7,77			
2	97 0 985531	315	PN10	508,79	232,80	151,70	20,40	8,27	1	50/60/50
	PN16		30,00				12,17			

water / gas

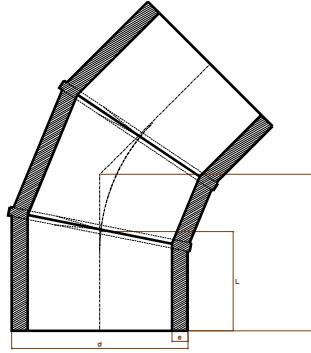

KONFEKSİYON 45 ° DİRSEK
SEGMENTED 45 ° ELBOW
COUDE SEGMENTÉ 45° / ОТВОД (Сварной) 45° / 45° (ملففة) كوع
PE100 - SDR 17 - PN10 ve SDR 11 - PN16

water / gas

SIRA	ÜRÜN KODU	ÇAP d [mm]	BASINÇ [bar]	L [mm]	z [mm]	r [mm]	e [mm]	AĞIRLIK [kg]	KOLİ ADEDİ	KOLİ EBATI
SEQ	PRODUCT CODE	SIZE d [mm]	PRESSURE [bar]					WEIGHT [kg]	IN A PARCEL	PARCEL SIZE
1	97 9 140250	250	PN10	185,00	285,12	241,71	14,80	6,11	-	-
	97 0 140250		PN16				22,70	8,99		
2	97 9 140280	280	PN10	200,00	308,24	261,32	16,60	8,22	-	-
	97 0 140280		PN16				25,40	12,18		
3	97 9 140315	315	PN10	210,00	323,65	274,38	18,70	10,96	-	-
	97 0 140315		PN16				28,60	16,13		
4	97 9 140355	355	PN10	233,00	359,10	304,43	21,10	15,45	-	-
	97 0 140355		PN16				32,20	22,72		
5	97 9 140400	400	PN10	247,00	380,68	322,72	23,70	20,75	-	-
	97 0 140400		PN16				36,30	30,60		
6	97 9 140450	450	PN10	260,00	400,71	339,71	26,70	27,61	-	-
	97 0 140450		PN16				40,90	40,79		
7	97 9 140500	500	PN10	273,00	420,75	356,69	29,70	35,87	-	-
	97 0 140500		PN16				45,40	52,83		
8	97 9 140560	560	PN10	287,00	442,30	374,98	33,20	47,18	-	-
	97 0 140560		PN16				50,80	69,57		
9	97 9 140630	630	PN10	320,00	493,18	418,00	37,40	66,62	-	-
	97 0 140630		PN16				57,20	97,92		
10	97 9 140710	710	PN10	368,00	567,16	480,82	42,10	97,26	-	-
	97 0 140710		PN16				64,50	143,52		
11	97 9 140800	800	PN10	383,00	590,28	500,42	47,40	128,69	-	-
	97 0 140800		PN16				72,80	194,18		
12	97 9 140900	900	PN10	433,00	667,34	565,74	53,30	183,16	-	-
	97 0 140900		PN16				81,70	272,79		
13	97 9 141000	1000	PN10	450,00	693,54	589,50	59,30	236,25	-	-
	97 0 141000		PN16				90,80	349,65		
14	97 9 141200	1200	PN10	500,00	770,00	655,00	70,60	382,50	-	-
	97 0 141200		PN16				-	-		
15	97 9 141400	1400	PN10	633,00	974,82	829,23	83,00	655,16	-	-
	97 0 141400		PN16				-	-		
16	97 9 141600	1600	PN10	733,00	1128,82	960,23	94,80	996,15	-	-
	97 0 141600		PN16				-	-		

"Yıldız bize, Biz Su'ya yön gösteriyoruz..."
 "The stars show us the way, we show way to the water..."

www.yildizpolietilen.com

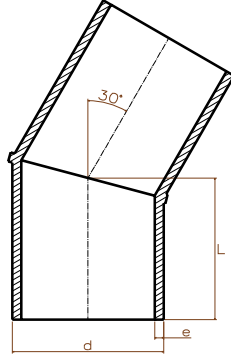

KONFEKSİYON 30 ° DİRSEK
 SEGMENTED 30 ° ELBOW

COUDE SEGMENTÉ 30° / ОТВОД (Сварной) 30° / 30° (كوع ملفقة)
 PE100 - SDR 17 - PN10 ve SDR 11 - PN16

SIRA	ÜRÜN KODU	ÇAP d [mm]	BASINÇ [bar]	L [mm]	e [mm]	AĞIRLIK [kg]	KOLİ ADEDİ	KOLİ EBATI
SEQ	PRODUCT CODE	SIZE d [mm]	PRESSURE [bar]			WEIGHT [kg]	IN A PARCEL	PARCEL SIZE
1	97 9 130090	90	PN10	140,00	5,40	0,41	-	-
	97 0 130090		PN16		8,20	0,59	-	-
2	97 9 130110	110	PN10	140,00	6,60	0,61	-	-
	97 0 130110		PN16		10,00	0,88	-	-
3	97 9 130125	125	PN10	150,00	7,40	0,83	-	-
	97 0 130125		PN16		11,40	1,22	-	-
4	97 9 130140	140	PN10	160,00	8,30	1,11	-	-
	97 0 130140		PN16		12,70	1,63	-	-
5	97 9 130160	160	PN10	170,00	9,50	1,54	-	-
	97 0 130160		PN16		14,60	2,27	-	-
6	97 9 130180	180	PN10	180,00	10,70	2,06	-	-
	97 0 130180		PN16		16,40	3,03	-	-
7	97 9 130200	200	PN10	190,00	11,90	2,68	-	-
	97 0 130200		PN16		18,20	3,95	-	-
8	97 9 130225	225	PN10	200,00	13,40	3,57	-	-
	97 0 130225		PN16		20,50	5,24	-	-
9	97 9 130250	250	PN10	210,00	14,80	4,62	-	-
	97 0 130250		PN16		22,70	6,80	-	-
10	97 9 130280	280	PN10	220,00	16,60	6,03	-	-
	97 0 130280		PN16		25,40	8,93	-	-
11	97 9 130315	315	PN10	230,00	18,70	8,00	-	-
	97 0 130315		PN16		28,60	11,78	-	-
12	97 9 130355	355	PN10	240,00	21,10	10,61	-	-
	97 0 130355		PN16		32,20	15,60	-	-
13	97 9 130400	400	PN10	250,00	23,70	14,00	-	-
	97 0 130400		PN16		36,30	20,65	-	-
14	97 9 130450	450	PN10	260,00	26,70	18,41	-	-
	97 0 130450		PN16		40,90	27,20	-	-
15	97 9 130500	500	PN10	270,00	29,70	23,65	-	-
	97 0 130500		PN16		45,40	34,83	-	-
16	97 9 130560	560	PN10	280,00	33,20	30,69	-	-
	97 0 130560		PN16		50,80	45,25	-	-

water / gas

KONFEKSİYON 30° DİRSEK - SEGMENTED 30° ELBOW / COUDE SEGMENTÉ 30° / ОТВОД (Сварной) 30° / 30° (ملفقة) كوع

PE100 - SDR 17 - PN10 ve SDR 11 - PN16

SIRA	ÜRÜN KODU	ÇAP d [mm]	BASINÇ [bar]	L [mm]	e [mm]	AĞIRLIK [kg]	KOLİ ADEDİ	KOLİ EBATI
SEQ	PRODUCT CODE	SIZE d [mm]	PRESSURE [bar]			WEIGHT [kg]	IN A PARCEL	PARCEL SIZE
17	97 9 130630	630	PN10	320,00	37,40	44,42	-	-
	97 0 130630		PN16		57,20	65,28	-	-
18	97 9 130710	710	PN10	340,00	42,10	59,91	-	-
	97 0 130710		PN16		64,50	88,40	-	-
19	97 9 130800	800	PN10	370,00	47,40	82,88	-	-
	97 0 130800		PN16		72,80	125,06	-	-
20	97 9 130900	900	PN10	390,00	53,30	109,98	-	-
	97 0 130900		PN16		81,70	163,80	-	-
21	97 9 131000	1000	PN10	420,00	59,30	147,00	-	-
	97 0 131000		PN16		90,80	217,56	-	-
22	97 9 131200	1200	PN10	550,00	70,60	280,50	-	-
	97 0 131200		PN16		-	-	-	-
23	97 9 131400	1400	PN10	600,00	83,00	414,00	-	-
	97 0 131400		PN16		-	-	-	-
24	97 9 131600	1600	PN10	700,00	94,80	634,20	-	-
	97 0 131600		PN16		-	-	-	-

water / gas

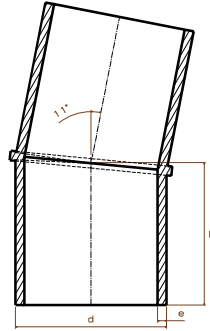

KONFEKSİYON 11° DİRSEK
SEGMENTED 11° ELBOW

COUDE SEGMENTÉ 11° / ОТВОД (Сварной) 11° / 11° (ملفقة) كوع

PE100 - SDR 17 - PN10 ve SDR 11 - PN16

SIRA	ÜRÜN KODU	ÇAP d [mm]	BASINÇ [bar]	L [mm]	e [mm]	AĞIRLIK [kg]	KOLİ ADEDİ	KOLİ EBATI
SEQ	PRODUCT CODE	SIZE d [mm]	PRESSURE [bar]			WEIGHT [kg]	IN A PARCEL	PARCEL SIZE
1	97 9 110090	90	PN10	130,00	5,40	0,38	-	-
	97 0 110090		PN16		8,20	0,55	-	-
2	97 9 110110	110	PN10	130,00	6,60	0,56	-	-
	97 0 110110		PN16		10,00	0,82	-	-
3	97 9 110125	125	PN10	140,00	7,40	0,77	-	-
	97 9 110125		PN16		11,40	1,14	-	-
4	97 9 110140	140	PN10	150,00	8,30	1,04	-	-
	97 0 110140		PN16		12,70	1,52	-	-
5	97 9 110160	160	PN10	160,00	9,50	1,45	-	-
	97 9 110160		PN16		14,60	2,13	-	-

"Yıldız bize, Biz Su'ya yön gösteriyoruz..."
 "The stars show us the way, we show way to the water..."

www.yildizpolietilen.com



KONFEKSİYON 11° DİRSEK - SEGMENTED 11° ELBOW / COUDE SEGMENTÉ 11° / ОТВОД (Сварной) 11° / 11° (مملفة) كوع
 PE100 - SDR 17 - PN10 ve SDR 11 - PN16

SIRA	ÜRÜN KODU	ÇAP d [mm]	BASINÇ [bar]	L [mm]	e [mm]	AĞIRLIK [kg]	KOLİ ADEDİ	KOLİ EBATI
SEQ	PRODUCT CODE	SIZE d [mm]	PRESSURE [bar]			WEIGHT [kg]	IN A PARCEL	PARCEL SIZE
6	97 9 110180	180	PN10	170,00	10,70	1,94	-	-
	97 0 110180		PN16		16,40	2,86	-	-
7	97 9 110200	200	PN10	180,00	11,90	2,54	-	-
	97 0 110200		PN16		18,20	3,74	-	-
8	97 9 110225	225	PN10	190,00	13,40	3,39	-	-
	97 0 110225		PN16		20,50	4,98	-	-
9	97 9 110250	250	PN10	200,00	14,80	4,40	-	-
	97 0 110250		PN16		22,70	6,48	-	-
10	97 9 110280	280	PN10	210,00	16,60	5,75	-	-
	97 0 110280		PN16		25,40	8,53	-	-
11	97 9 110315	315	PN10	220,00	18,70	7,66	-	-
	97 0 110315		PN16		28,60	11,26	-	-
12	97 9 110355	355	PN10	230,00	21,10	10,17	-	-
	97 0 110355		PN16		32,20	14,95	-	-
13	97 9 110400	400	PN10	240,00	23,70	13,44	-	-
	97 0 110400		PN16		36,30	19,82	-	-
14	97 9 110450	450	PN10	250,00	26,70	17,70	-	-
	97 0 110450		PN16		40,90	26,15	-	-
15	97 9 110500	500	PN10	260,00	29,70	22,78	-	-
	97 0 110500		PN16		45,40	33,54	-	-
16	97 9 110560	560	PN10	270,00	33,20	29,59	-	-
	97 0 110560		PN16		50,80	43,63	-	-
17	97 9 110630	630	PN10	300,00	37,40	41,64	-	-
	97 0 110630		PN16		57,20	61,20	-	-
18	97 9 110710	710	PN10	320,00	42,10	56,38	-	-
	97 0 110710		PN16		64,50	83,20	-	-
19	97 9 110800	800	PN10	350,00	47,40	78,40	-	-
	97 0 110800		PN16		72,80	118,30	-	-
20	97 9 110900	900	PN10	370,00	53,30	104,34	-	-
	97 0 110900		PN16		81,70	155,40	-	-
21	97 9 111000	1000	PN10	400,00	59,30	140,00	-	-
	97 0 111000		PN16		90,80	207,20	-	-
22	97 9 111200	1200	PN10	500,00	71,10	255,00	-	-
	97 0 111200		PN16		-	-	-	-
23	97 9 111400	1400	PN10	550,00	83,00	379,50	-	-
	97 0 111400		PN16		-	-	-	-
24	97 9 111600	1600	PN10	620,00	94,80	561,72	-	-
	97 0 111600		PN16		-	-	-	-

water / gas



YILDIZ
for the best
Polietilen

Ø 32 [mm] - Ø1600 [mm]

TE - TEE - TÉ / ТРОЙНИК / تي

EŞİT TE - EQUAL TEE, İNEGAL TE - REUDED TEE, DÖRT KÖŞE TE - CROSS TEE

DÖRT KÖŞE İNEGAL TE - REDUCED CROSS TEE, Y ÇATAL - BRANCH TEE

Y ÇATAL İNEGAL TE - SPECIAL DEGREE REDUCED TEE

Té, Té réduit, Croix, Croix réduit, Té 45°

РАВНОПРОХОДНОЙ ТРОЙНИК, НЕ РАВНОПРОХОДНОЙ ТРОЙНИК, КРЕСТОВИНА, НЕ РАВНОПРОХОДНОЙ КОСОЙТРОЙНИК, РАВНОПРОХОДНОЙ КОСОЙТРОЙНИК

تي متساوية تي غير متساوية تي صليبة متساوية تي صليبة غير متساوية

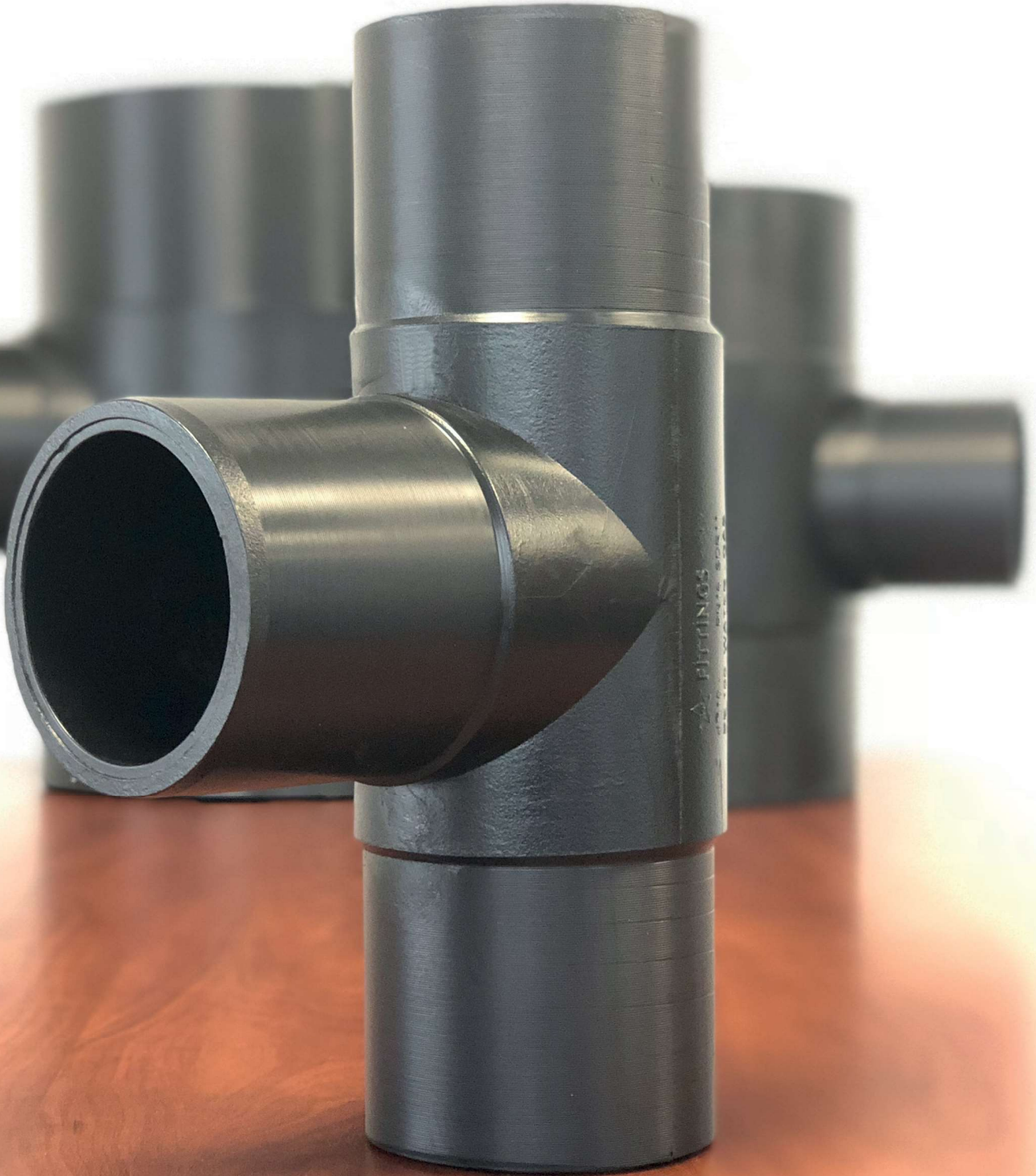

"Yıldız bize, Biz Su'ya yön gösteriyoruz..."
 "The stars show us the way, we show way to the water..."

www.yildizpolietilen.com

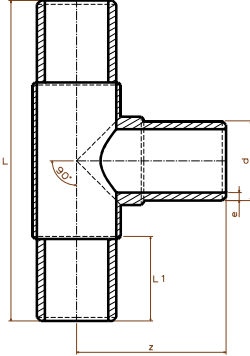

ENJEKSİYON EŞİT TE
 INJECTION EQUAL TEE

TE 90° INJECTÉ / РАВНОПРОХОДНОЙ ТРОЙНИК 90° (Литой) / تي متساوية (حقن)

PE100 - SDR 17 - PN10 ve SDR 11 - PN16

SIRA	ÜRÜN KODU	ÇAP d [mm]	BASINÇ [bar]	L [mm]	z [mm]	L ₁ [mm]	e [mm]	AĞIRLIK [kg]	KOLİ ADEDİ	KOLİ EBATİ
SEQ.	PRODUCT CODE	SIZE d [mm]	PRESSURE [bar]					WEIGHT [kg]	IN A PARCEL	PCS PRICE
1	97 2 323003	32/32	PN10	173,00	80,00	45,00	2,30	0,07	100	30/60/41
	97 3 323003		PN16					3,00		
2	97 2 323004	40/40	PN10	186,00	96,30	53,00	2,80	0,10	80	30/60/41
	97 3 323004		PN16					4,05		
3	97 2 323005	50/50	PN10	214,00	111,20	60,30	3,40	0,19	50	30/60/41
	97 3 323005		PN16					4,80		
4	97 2 323006	63/63	PN10	247,00	121,90	65,00	4,12	0,31	32	30/60/41
	97 3 323006		PN16					6,37		
5	97 2 323007	75/75	PN10	277,30	133,30	69,80	4,79	0,50	20	30/60/41
	97 3 323007		PN16					7,40		
6	97 2 323009	90/90	PN10	288,70	148,00	80,00	5,80	0,71	16	30/60/41
	97 3 323009		PN16					9,20		
7	97 2 323011	110/110	PN10	343,00	165,90	89,50	6,60	1,30	14	41/60/46
	97 3 323011		PN16					10,20		
8	97 2 323012	125/125	PN10	374,00	192,50	100,90	8,15	1,61	10	41/60/46
	97 3 323012		PN16					12,60		
9	97 2 323014	140/140	PN10	358,00	182,00	93,00	8,54	1,67	8	41/60/46
	97 3 323014		PN16					13,20		
10	97 2 323016	160/160	PN10	485,00	214,00	109,10	10,60	3,40	7	50/60/50
	97 2 323016		PN16					14,65		
11	97 2 323018	180/180	PN10	515,00	232,00	113,96	10,80	3,96	4	50/60/50
	97 2 323018		PN16					16,50		
12	97 2 323020	200/200	PN10	505,00	243,00	122,30	11,70	5,70	3	50/60/50
	97 3 323020		PN16					18,70		
13	97 2 323022	225/225	PN10	533,00	251,50	121,70	13,50	6,53	3	50/60/50
	97 3 323022		PN16					20,60		
14	97 2 323025	250/250	PN10	583,00	284,00	132,45	20,50	11,20	2	50/60/50
	97 3 323025		PN16					23,20		
15	97 2 323028	280/280	PN10	590,00	290,00	136,80	16,70	11,50	1	50/60/50
	97 3 323028		PN16					25,50		
16	97 2 323031	315/315	PN10	715,00	337,50	152,65	20,70	17,90	-	-
	97 3 323031		PN16					31,20		

water / gas

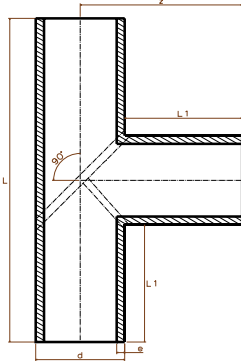

KONFEKSİYON EŞİT TE
SEGMENTED EQUAL TEE

ТЭ 90° SEGMENTÉ / РАВНОПРОХОДНОЙ ТРОЙНИК 90° (Сварной) / تي متساوية ملفقة)
PE100 - SDR 17 - PN10 ve SDR 11 - PN16

water / gas

SIRA	ÜRÜN KODU	ÇAP d [mm]	BASINÇ [bar]	L [mm]	L ₁ [mm]	z [mm]	e [mm]	AĞIRLIK [kg]	KOLİ ADEDİ	KOLİ EBATI
SEQ	PRODUCT CODE	SIZE d [mm]	PRESSURE [bar]					WEIGHT [kg]	IN A PARCEL	PARCEL SIZE
1	97 2 250250	250*250	PN10	640,00	195,00	320,00	14,80	10,56	-	-
	97 3 250250		PN16					22,70		
2	97 2 280280	280*280	PN10	680,00	200,00	340,00	16,60	13,97	-	-
	97 3 280280		PN16					25,40		
3	97 2 315315	315*315	PN10	800,00	242,50	400,00	18,70	20,88	-	-
	97 3 315315		PN16					28,60		
4	97 2 355355	355*355	PN10	866,67	255,83	433,33	21,10	28,73	-	-
	97 3 355355		PN16					32,20		
5	97 2 400400	400*400	PN10	933,33	266,67	466,67	23,70	39,20	-	-
	97 3 400400		PN16					36,30		
6	97 2 450450	450*450	PN10	1000,00	275,00	500,00	26,70	53,10	-	-
	97 3 450450		PN16					40,90		
7	97 2 500500	500*500	PN10	1106,67	303,33	553,33	29,70	72,71	-	-
	97 3 500500		PN16					45,40		
8	97 2 560560	560*560	PN10	1200,00	320,00	600,00	33,20	98,64	-	-
	97 3 560560		PN16					50,80		
9	97 2 630630	630*630	PN10	1280,00	325,00	640,00	37,40	133,25	-	-
	97 3 630630		PN16					57,20		
10	97 2 710710	710*710	PN10	1400,00	345,00	700,00	42,10	185,01	-	-
	97 3 710710		PN16					64,50		
11	97 2 800800	800*800	PN10	1506,67	353,33	753,33	47,40	253,12	-	-
	97 3 800800		PN16					72,80		
12	97 2 900900	900*900	PN10	1706,67	403,33	853,33	53,30	360,96	-	-
	97 3 900900		PN16					81,70		
13	97 2 001000	1000*1000	PN10	1773,33	386,67	886,67	59,30	465,50	-	-
	97 3 001000		PN16					90,80		
14	97 2 001200	1200*1200	PN10	2300,00	550,00	1150,00	70,60	879,75	-	-
	97 3 001200		PN16					-		
15	97 2 001400	1400*1400	PN10	2566,67	583,33	1283,33	83,00	1328,25	-	-
	97 3 001400		PN16					-		
16	97 2 001600	1600*1600	PN10	2833,33	616,67	1416,67	94,80	1925,25	-	-
	97 3 001600		PN16					-		

"Yıldız bize, Biz Su'ya yön gösteriyoruz..."
 "The stars show us the way, we show way to the water..."

www.yildizpolietilen.com

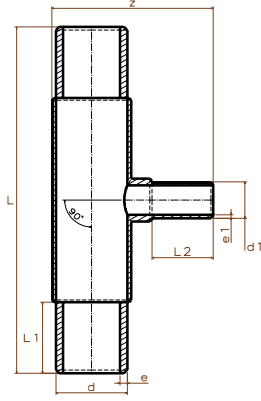

ENJEKSİYON İNEGAL TE
 INJECTION REDUCED TEE

TÉ RÉDUIT 90° INJECTÉ / НЕ РАВНОПРОХОДНОЙ ТРОЙНИК 90° (Литой) / تي غيرمتساوية (حقن)
 PE100 - SDR 17 - PN10 ve SDR 11 - PN16

SIRA	ÜRÜN KODU	ÇAP d/d1 [mm]	BASINÇ [bar]	L [mm]	z [mm]	L ₁ [mm]	L ₂ [mm]	e [mm]	e ₁ [mm]	AĞIRLIK [kg]	KOLİ ADEDİ	KOLİ EBATI
SEQ	PRODUCT CODE	SIZE d/d1 [mm]	PRESSURE [bar]	L [mm]	z [mm]	L ₁ [mm]	L ₂ [mm]	e [mm]	e ₁ [mm]	WEIGHT [kg]	IN A PARCEL	PCS PRICE
1	97 0 004032	40/32	PN10	185,70	115,66	54,90	54,90	2,60	2,10	0,09	70	41/60/31
	PN16		4,10					3,00	0,14			
2	97 0 005032	50/32	PN10	214,00	118,00	60,00	55,70	3,10	2,20	0,16	56	41/60/31
	PN16		4,70					3,00	0,24			
3	97 0 005040	50/40	PN10	214,40	124,30	57,80	58,50	3,20	2,50	0,05	56	41/60/31
	PN16		4,90					4,00	0,26			
4	97 0 006325	63/25	PN10	279,00	153,15	101,10	79,10	4,00	2,00	0,23	45	41/60/31
	PN16		6,40					2,70	0,35			
5	97 0 006332	63/32	PN10	243,00	136,60	62,80	54,00	4,10	2,10	0,25	36	41/60/31
	PN16		6,20					3,10	0,37			
6	97 0 006340	63/40	PN10	247,47	137,20	65,25	56,40	4,10	2,50	0,07	36	41/60/31
	PN16		6,30					4,00	0,39			
7	97 0 006350	63/50	PN10	239,60	143,90	62,40	57,10	4,20	3,20	0,26	35	41/60/31
	PN16		6,30					4,70	0,39			
8	97 0 007532	75/32	PN10	272,50	149,55	67,55	50,00	4,70	2,30	0,39	25	41/60/31
	PN16		7,50					3,40	0,58			
9	97 0 007540	75/40	PN10	276,80	158,50	69,00	60,90	4,90	2,80	0,43	25	41/60/31
	PN16		7,60					4,10	0,65			
10	97 0 007550	75/50	PN10	272,30	163,40	68,00	63,00	5,00	3,40	0,41	24	41/60/31
	PN16		7,50					5,20	0,62			
11	97 0 007563	75/63	PN10	277,25	164,60	69,00	68,00	5,00	4,10	0,47	22	41/60/31
	PN16		7,60					6,63	0,70			
12	97 0 009025	90/25	PN10	283,40	154,40	76,30	36,60	5,60	2,00	0,53	21	41/60/31
	PN16		9,10					2,70	0,79			
13	97 0 009032	90/32	PN10	239,80	162,00	82,70	50,00	5,80	2,30	0,56	20	41/60/31
	PN16		9,20					3,40	0,84			
14	97 0 009040	90/40	PN10	290,00	161,90	80,00	46,00	5,80	2,60	0,56	20	41/60/31
	PN16		9,00					4,20	0,84			
15	97 0 009050	90/50	PN10	288,00	169,00	78,40	58,14	5,90	3,20	0,59	18	41/60/31
	PN16		9,20					5,20	0,89			
16	97 0 009063	90/63	PN10	286,00	180,00	77,30	69,00	6,00	4,20	0,62	16	41/60/31
	PN16		9,10					6,30	0,93			

water / gas

ENJEKSİYON İNEGAL TE - INJECTION REDUCED TEE - PE100 - SDR 17 - PN10 ve SDR 11 - PN16

TÉ RÉDUIT 90° INJECTÉ / НЕ РАВНОПРОХОДНОЙ ТРОЙНИК 90° (Литой) / تي غيرمتساوية (حقن)

water / gas

SIRA	ÜRÜN KODU	ÇAP d/d1 [mm]	BASINÇ [bar]	L [mm]	z [mm]	L ₁ [mm]	L ₂ [mm]	e [mm]	e ₁ [mm]	AĞIRLIK [kg]	KOLİ ADEDİ	KOLİ EBATI
SEQ.	PRODUCT CODE	SIZE d/d1 [mm]	PRESSURE [bar]							WEIGHT [kg]	IN A PARCEL	PCS PRICE
17	97 0 009075	90/75	PN10	286,00	180,00	70,70	70,00	6,00	4,90	0,63	16	41/60/31
	97 1 009075		PN16							0,94		
18	97 0 011032	110/32	PN10	348,00	195,00	90,00	68,00	6,60	2,30	1,11	20	41/60/46
	97 1 011032		PN16							1,67		
19	97 0 011040	110/40	PN10	342,00	185,00	89,10	56,60	6,90	2,80	0,83	18	41/60/46
	97 1 011040		PN16							1,24		
20	97 0 011050	110/50	PN10	352,00	193,00	92,95	61,00	7,00	3,30	0,91	18	41/60/46
	97 1 011050		PN16							1,36		
21	97 0 011063	110/63	PN10	340,00	199,00	89,25	68,60	7,00	4,20	0,84	17	41/60/46
	97 1 011063		PN16							1,26		
22	97 0 011075	110/75	PN10	342,00	206,60	88,80	79,55	7,10	5,00	0,89	16	41/60/46
	97 1 011075		PN16							1,34		
23	97 0 011090	110/90	PN10	340,00	214,40	88,00	80,34	7,20	6,00	0,94	15	41/60/46
	97 1 011090		PN16							1,41		
24	97 0 012532	125/32	PN10	365,00	229,40	93,85	53,30	7,60	2,20	1,29	12	41/60/46
	97 1 012532		PN16							1,93		
25	97 0 012550	125/50	PN10	368,00	229,40	111,50	78,35	7,80	3,40	1,29	11	41/60/46
	97 1 012550		PN16							1,93		
26	97 0 012563	125/63	PN10	368,00	228,40	97,00	73,00	8,00	4,20	1,36	10	41/60/46
	97 1 012563		PN16							2,04		
27	97 0 012575	125/75	PN10	370,00	233,50	96,80	79,90	7,60	5,00	1,40	10	41/60/46
	97 1 012575		PN16							2,10		
28	97 0 012590	125/90	PN10	372,00	236,00	100,00	78,00	7,80	5,90	1,44	10	41/60/46
	97 1 012590		PN16							2,16		
29	97 0 125110	125/110	PN10	371,00	246,50	94,30	92,00	8,00	6,80	1,57	10	41/60/46
	97 1 125110		PN16							2,35		
30	97 0 014050	140/50	PN10	350,00	277,00	87,00	57,00	8,50	3,40	1,63	10	41/60/46
	97 1 014050		PN16							2,44		
31	97 0 014063	140/63	PN10	351,00	272,75	87,00	59,00	8,60	4,30	1,41	10	41/60/46
	97 1 014063		PN16							2,12		
32	97 0 014075	140/75	PN10	354,00	225,40	90,00	72,00	8,60	5,10	1,45	10	41/60/46
	97 1 014075		PN16							2,18		
33	97 0 014090	140/90	PN10	355,00	232,00	89,00	77,77	8,50	6,00	1,49	10	41/60/46
	97 1 014090		PN16							2,24		
34	97 0 140110	140/110	PN10	355,00	241,30	89,00	83,00	8,60	7,20	1,53	10	41/60/46
	97 1 140110		PN16							2,29		
35	97 0 140125	140/125	PN10	357,00	239,20	89,00	81,10	8,60	8,00	1,67	8	41/60/46
	97 1 140125		PN16							2,50		
36	97 0 016032	160/32	PN10	484,00	226,10	106,00	49,00	9,80	2,30	2,64	9	50/60/50
	97 1 016032		PN16							3,96		

"Yıldız bize, Biz Su'ya yön gösteriyoruz..."
 "The stars show us the way, we show way to the water..."

www.yildizpolietilen.com



ENJEKSİYON İNEĞAL TE - INJECTION REDUCED TEE - PE100 - SDR 17 - PN10 ve SDR 11 - PN16

TÉ RÉDUIT 90° INJECTÉ / НЕ РАВНОПРОХОДНОЙ ТРОЙНИК 90° (Литой) / تي غيرمتساوية (حقن)

SIRA	ÜRÜN KODU	ÇAP d/d1 [mm]	BASINÇ [bar]	L [mm]	z [mm]	L ₁ [mm]	L ₂ [mm]	e [mm]	e ₁ [mm]	AĞIRLIK [kg]	KOLİ ADEDİ	KOLİ EBATI
SEQ	PRODUCT CODE	SIZE d/d1 [mm]	PRESSURE [bar]							WEIGHT [kg]	IN A PARCEL	PCS PRICE
37	97 0 016050	160/50	PN10	480,00	276,50	106,85	62,35	10,00	3,40	2,59	9	50/60/50
	PN16		14,60					5,20	3,88			
38	97 0 016063	160/63	PN10	481,00	256,00	106,60	70,00	10,00	4,20	2,58	9	50/60/50
	PN16		14,70					5,80	3,87			
39	97 0 016075	160/75	PN10	480,00	252,00	118,00	72,00	10,20	5,10	2,53	8	50/60/50
	PN16		15,00					6,80	3,80			
40	97 0 016090	160/90	PN10	488,00	277,70	103,30	91,00	10,50	5,80	2,71	8	50/60/50
	PN16		15,50					8,70	4,06			
41	97 0 160110	160/110	PN10	489,00	277,70	108,20	93,00	10,30	6,90	2,80	8	50/60/50
	PN16		14,60					11,10	4,20			
42	97 0 160125	160/125	PN10	480,00	289,65	107,40	102,40	10,20	7,60	2,77	8	50/60/50
	PN16		15,10					12,30	4,16			
43	97 0 160140	160/140	PN10	485,00	285,00	110,00	103,00	10,40	9,00	3,10	7	50/60/50
	PN16		16,00					13,00	4,65			
44	97 0 018090	180/90	PN10	506,00	305,00	114,25	95,40	11,00	5,80	3,44	5	50/60/50
	PN16		16,40					8,80	5,16			
45	97 0 180110	180/110	PN10	517,00	310,00	113,00	100,00	11,00	7,20	3,57	5	50/60/50
	PN16		16,40					10,50	5,35			
46	97 0 180125	180/125	PN10	510,00	307,30	114,80	102,40	11,20	8,00	3,53	5	50/60/50
	PN16		16,50					11,50	5,29			
47	97 0 180140	180/140	PN10	508,00	312,00	112,00	104,00	11,10	8,80	3,75	4	50/60/50
	PN16		16,60					13,60	5,63			
48	97 0 180160	180/160	PN10	508,00	315,00	114,00	110,00	11,50	10,20	3,73	4	50/60/50
	PN16		16,90					16,00	5,60			
49	97 0 020063	200/63	PN10	500,00	390,00	125,25	71,40	12,00	4,20	4,37	5	50/60/50
	PN16		19,10					6,00	6,56			
50	97 0 020075	200/75	PN10	505,00	335,00	120,00	72,00	12,20	5,00	4,47	5	50/60/50
	PN16		19,60					7,00	6,70			
51	97 0 020090	200/90	PN10	501,00	335,00	122,00	101,00	12,00	5,80	4,47	5	50/60/50
	PN16		18,70					8,20	6,70			
52	97 0 200110	200/110	PN10	507,00	331,00	120,00	108,00	12,20	6,80	4,57	4	50/60/50
	PN16		18,30					10,00	6,85			
53	97 0 200125	200/125	PN10	502,00	336,00	120,00	111,86	13,20	8,30	5,24	4	50/60/50
	PN16		20,20					11,50	7,86			
54	97 0 200140	200/140	PN10	500,00	335,00	120,60	115,40	12,50	9,00	4,73	4	50/60/50
	PN16		19,60					14,00	7,09			
55	97 0 200160	200/160	PN10	508,00	335,00	120,00	110,00	12,50	10,00	4,83	4	50/60/50
	PN16		20,10					16,10	7,25			
56	97 0 200180	200/180	PN10	504,00	348,00	121,30	109,50	13,00	11,60	4,87	3	50/60/50
	PN16		20,00					16,60	7,31			

water / gas

ENJEKSİYON İNEGAL TE - INJECTION REDUCED TEE - PE100 - SDR 17 - PN10 ve SDR 11 - PN16

تغيرمتساوية (حقن) / НЕ РАВНОПРОХОДНОЙ ТРОЙНИК 90° (Литой) / TÉ RÉDUIT 90° INJECTÉ

SIRA	ÜRÜN KODU	ÇAP d/d1 [mm]	BASINÇ [bar]	L [mm]	z [mm]	L ₁ [mm]	L ₂ [mm]	e [mm]	e ₁ [mm]	AĞIRLIK [kg]	KOLİ ADEDİ	KOLİ EBATİ
SEQ.	PRODUCT CODE	SIZE d/d1 [mm]	PRESSURE [bar]							WEIGHT [kg]	IN A PARCEL	PCS PRICE
57	97 0 022563	225/63	PN10	534,00	334,50	122,00	85,00	13,50	4,30	4,52	4	50/60/58
	97 1 022563		PN16					20,90	6,00	6,78		
58	97 0 022575	225/75	PN10	534,00	337,50	122,00	87,00	14,00	5,10	4,61	4	50/60/58
	97 1 022575		PN16					21,00	7,20	6,91		
59	97 0 022590	225/90	PN10	528,00	320,00	120,00	80,80	13,60	6,00	7,11	4	50/60/58
	97 1 022590		PN16					22,70	9,20	10,67		
60	97 0 225110	225/110	PN10	540,00	327,50	120,00	87,00	13,50	7,30	5,99	4	50/60/58
	97 1 225110		PN16					21,20	10,80	8,99		
61	97 0 225125	225/125	PN10	528,00	330,00	121,45	91,00	14,40	8,10	5,26	4	50/60/58
	97 1 225125		PN16					20,50	11,40	7,89		
62	97 0 225140	225/140	PN10	532,00	349,22	123,23	108,80	13,50	9,30	6,26	4	50/60/58
	97 1 225140		PN16					20,60	12,90	8,26		
63	97 0 225160	225/160	PN10	530,00	360,00	120,30	110,00	14,60	10,20	5,46	4	50/60/58
	97 1 225160		PN16					20,60	15,00	8,19		
64	97 0 225180	225/180	PN10	538,00	358,50	120,00	112,00	14,00	11,50	6,64	3	50/60/58
	97 1 225180		PN16					22,70	16,40	9,96		
65	97 0 225200	225/200	PN10	538,00	360,00	121,55	114,60	14,00	12,10	5,99	3	50/60/58
	97 1 225200		PN16					20,80	18,60	8,98		
66	97 0 025090	250/90	PN10	573,00	350,00	134,50	84,70	14,90	5,80	5,08	3	50/60/58
	97 1 025090		PN16					22,90	8,30	7,62		
67	97 0 250110	250/110	PN10	575,00	352,00	130,95	90,30	16,40	6,70	9,02	3	50/60/58
	97 1 250110		PN16					23,20	11,00	13,53		
68	97 0 250125	250/125	PN10	570,00	365,00	130,00	85,00	16,40	8,10	6,33	3	50/60/58
	97 1 250125		PN16					24,00	12,10	9,50		
69	97 0 250140	250/140	PN10	575,00	378,00	131,80	110,00	16,40	9,30	9,28	3	50/60/58
	97 1 250140		PN16					23,20	13,00	10,91		
70	97 0 250160	250/160	PN10	570,00	390,00	130,00	110,00	16,30	10,30	7,33	3	50/60/58
	97 1 250160		PN16					24,10	14,80	11,00		
71	97 0 250180	250/180	PN10	577,00	400,00	130,00	137,10	16,00	11,60	7,72	3	50/60/58
	97 1 250180		PN16					24,36	16,60	11,58		
72	97 0 250200	250/200	PN10	573,00	390,00	130,00	107,65	16,20	12,80	7,61	2	50/60/58
	97 1 250200		PN16					24,24	18,60	11,41		
73	97 0 250225	250/225	PN10	570,00	385,00	130,00	114,00	16,30	14,80	11,95	2	50/60/58
	97 1 250225		PN16					22,70	21,40	17,93		
74	97 0 028090	280/90	PN10	420,00	383,00	115,00	85,00	17,00	6,00	6,07	2	41/60/46
	97 1 028090		PN16					25,90	9,00	9,10		
75	97 0 280110	280/110	PN10	430,00	405,00	114,30	92,20	16,70	7,40	6,97	2	41/60/46
	97 1 280110		PN16					27,20	10,30	10,46		
76	97 0 280125	280/125	PN10	428,00	390,00	116,00	90,00	16,90	8,10	7,00	2	41/60/46
	97 1 280125		PN16					27,10	12,00	10,50		

water / gas

"Yıldız bize, Biz Su'ya yön gösteriyoruz..."
"The stars show us the way, we show way to the water..."

www.yildizpolietilen.com



ENJEKSİYON İNEGAL TE - INJECTION REDUCED TEE - PE100 - SDR 17 - PN10 ve SDR 11 - PN16
TÉ RÉDUIT 90° INJECTÉ / НЕ РАВНОПРОХОДНОЙ ТРОЙНИК 90° (Литой) / تي غيرمتساوية (حقن)

SIRA	ÜRÜN KODU	ÇAP d/d1 [mm]	BASINÇ [bar]	L [mm]	z [mm]	L ₁ [mm]	L ₂ [mm]	e [mm]	e ₁ [mm]	AĞIRLIK [kg]	KOLİ ADEDİ	KOLİ EBATI
SEQ	PRODUCT CODE	SIZE d/d1 [mm]	PRESSURE [bar]							WEIGHT [kg]	IN A PARCEL	PCS PRICE
77	97 0 280140	280/140	PN10	417,00	390,00	114,00	93,00	18,40	9,00	6,86	2	41/60/46
	97 1 280140		PN16							9,10		
78	97 0 280160	280/160	PN10	422,00	410,00	114,60	101,50	17,60	10,20	6,53	2	41/60/46
	97 1 280160		PN16							9,79		
79	97 0 031590	315/90	PN10	485,00	447,50	144,50	115,00	18,90	5,90	9,24	2	41/60/46
	97 1 031590		PN16							13,86		
80	97 0 315110	315/110	PN10	484,00	447,00	143,65	117,65	19,00	7,20	9,47	2	50/60/50
	97 1 315110		PN16							14,20		
81	97 0 315125	315/125	PN10	495,00	445,00	110,00	105,00	20,20	8,10	6,67	2	50/60/50
	97 1 315125		PN16							10,00		
82	97 0 315140	315/140	PN10	483,00	450,00	150,00	120,00	2,30	10,10	8,67	2	50/60/50
	97 1 315140		PN16							13,00		
83	97 0 315160	315/160	PN10	703,00	482,00	148,30	125,30	20,70	12,30	15,36	2	50/60/50
	97 1 315160		PN16							23,04		

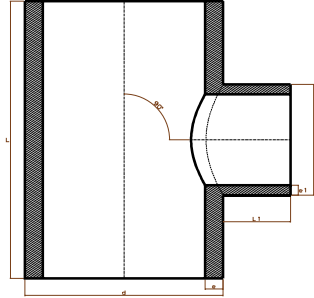

water / gas

KONFEKSİYON İNEGAL TE
SEGMENTED REDUCED TEE
PE100 - SDR 17 - PN10 ve SDR 11 - PN16

TÉ RÉDUIT 90° SEGMENTÉ / НЕ РАВНОПРОХОДНОЙ ТРОЙНИК 90° (Сварной) / تي غيرمتساوية (مفلقة)

SIRA	ÜRÜN KODU	ÇAP d [mm]	BASINÇ [bar]	L [mm]	L ₁ [mm]	z [mm]	e [mm]	e ₁ [mm]	AĞIRLIK [kg]	KOLİ ADEDİ
SEQ	PRODUCT CODE	SIZE d [mm]	PRESSURE [bar]						WEIGHT [kg]	IN A PARCEL
1	97 4 009050	90/50	PN10	320,00	110,00	155,00	5,40	3,00	0,52	-
	97 5 009050		PN16						0,75	
2	97 4 009063	90/63	PN10	320,00	110,00	155,00	5,40	3,80	0,55	-
	97 5 009063		PN16						0,79	
3	97 4 009075	90/75	PN10	360,00	110,00	155,00	5,40	4,50	0,64	-
	97 5 009075		PN16						0,92	
4	97 4 011050	110/50	PN10	320,00	110,00	165,00	6,60	3,00	0,74	-
	97 5 011050		PN16						1,08	
5	97 4 011063	110/63	PN10	320,00	110,00	165,00	6,60	3,80	0,77	-
	97 5 011063		PN16						1,12	
6	97 4 011075	110/75	PN10	360,00	110,00	165,00	6,60	4,50	0,89	-
	97 5 011075		PN16						1,29	
7	97 4 011090	110/90	PN10	400,00	130,00	185,00	6,60	5,40	1,06	-
	97 5 011090		PN16						1,53	
8	97 4 012550	125/50	PN10	320,00	110,00	172,50	7,40	3,00	0,93	-
	97 5 012550		PN16						1,38	

KONFEKSİYON İNEĞAL TE - SEGMENTED REDUCED TEE - PE100 - SDR 17 - PN10 ve SDR 11 - PN16
TÉ RÉDUIT 90° SEGMENTÉ / НЕ РАВНОПРОХОДНОЙ ТРОЙНИК 90° (Сварной) / تي غيرمتساوية (ملففة)

water / gas

SIRA	ÜRÜN KODU	ÇAP d [mm]	BASINÇ [bar]	L [mm]	L ₁ [mm]	z [mm]	e [mm]	e ₁ [mm]	AĞIRLIK [kg]	KOLİ ADEDİ
SEQ	PRODUCT CODE	SIZE d [mm]	PRESSURE [bar]						WEIGHT [kg]	IN A PARCEL
9	97 4 012563	125/63	PN10	320,00	110,00	172,50	7,40	3,80	0,96	-
	97 5 012563		PN16				11,40	5,80	1,42	
10	97 4 012575	125/75	PN10	360,00	110,00	172,50	7,40	4,50	1,10	-
	97 5 012575		PN16				11,40	6,80	1,63	
11	97 4 012590	125/90	PN10	360,00	130,00	192,50	7,40	5,40	1,18	-
	97 5 012590		PN16				11,40	8,20	1,74	
12	97 4 125110	125/110	PN10	400,00	130,00	192,50	7,40	6,60	1,38	-
	97 5 125110		PN16				11,40	10,00	2,04	
13	97 4 014050	140/50	PN10	320,00	110,00	180,00	8,30	3,00	1,16	-
	97 5 014050		PN16				12,70	4,60	1,70	
14	97 4 014063	140/63	PN10	320,00	110,00	180,00	8,30	3,80	1,19	-
	97 5 014063		PN16				12,70	5,80	1,74	
15	97 4 014075	140/75	PN10	360,00	110,00	180,00	8,30	4,50	1,36	-
	97 5 014075		PN16				12,70	6,80	1,99	
16	97 4 014090	140/90	PN10	450,00	130,00	200,00	8,30	5,40	1,75	-
	97 5 014090		PN16				12,70	8,20	2,56	
17	97 4 140110	140/110	PN10	450,00	130,00	200,00	8,30	6,60	1,84	-
	97 5 140110		PN16				12,70	10,00	2,69	
18	97 4 140125	140/125	PN10	550,00	130,00	200,00	8,30	7,40	2,26	-
	97 5 140125		PN16				12,70	11,40	3,32	
19	97 4 016050	160/50	PN10	320,00	110,00	190,00	9,50	3,00	1,50	-
	97 5 016050		PN16				14,60	4,60	2,21	
20	97 4 016063	160/63	PN10	320,00	110,00	190,00	9,50	3,80	1,53	-
	97 5 016063		PN16				14,60	5,80	2,25	
21	97 4 016075	160/75	PN10	360,00	110,00	190,00	9,50	4,50	1,74	-
	97 5 016075		PN16				14,60	6,80	2,56	
22	97 4 016090	160/90	PN10	450,00	130,00	210,00	9,50	5,40	2,22	-
	97 5 016090		PN16				14,60	8,20	3,28	
23	97 4 160110	160/110	PN10	450,00	130,00	210,00	9,50	6,60	2,32	-
	97 5 160110		PN16				14,60	10,00	3,41	
24	97 4 160125	160/125	PN10	450,00	130,00	210,00	9,50	7,40	2,39	-
	97 5 160125		PN16				14,60	11,40	3,53	
25	97 4 160140	160/140	PN10	550,00	150,00	230,00	9,50	8,30	3,01	-
	97 5 160140		PN16				14,60	12,70	4,43	
26	97 4 018050	180/50	PN10	320,00	110,00	200,00	13,30	3,00	1,88	-
	97 5 018050		PN16				16,40	4,60	2,77	
27	97 4 018063	180/63	PN10	320,00	110,00	200,00	13,30	3,80	1,91	-
	97 5 018063		PN16				16,40	5,80	2,81	
28	97 4 018075	180/75	PN10	360,00	110,00	200,00	13,30	4,50	2,17	-
	97 5 018075		PN16				16,40	6,80	3,19	

"Yıldız bize, Biz Su'ya yön gösteriyoruz..."
 "The stars show us the way, we show way to the water..."

www.yildizpolietilen.com



KONFEKSİYON İNEGAL TE - SEGMENTED REDUCED TEE - PE100 - SDR 17 - PN10 ve SDR 11 - PN16
 TÉ RÉDUIT 90° SEGMENTÉ / НЕ РАВНОПРОХОДНОЙ ТРОЙНИК 90° (Сварной) / تي غيرمتساوية (ملففة)

SIRA	ÜRÜN KODU	ÇAP d [mm]	BASINÇ [bar]	L [mm]	L ₁ [mm]	z [mm]	e [mm]	e ₁ [mm]	AĞIRLIK [kg]	KOLİ ADEDİ
SEQ	PRODUCT CODE	SIZE d [mm]	PRESSURE [bar]						WEIGHT [kg]	IN A PARCEL
29	97 4 018090	180/90	PN10	450,00	130,00	220,00	13,30	5,40	2,76	-
	97 5 018090		PN16				16,40	8,20	4,06	
30	97 4 180110	180/110	PN10	450,00	130,00	220,00	13,30	6,60	2,85	-
	97 5 180110		PN16				16,40	10,00	4,20	
31	97 4 180125	180/125	PN10	450,00	130,00	220,00	13,30	7,40	2,93	-
	97 5 180125		PN16				16,40	11,40	4,32	
32	97 4 180140	180/140	PN10	500,00	150,00	240,00	13,30	8,30	3,37	-
	97 5 180140		PN16				16,40	12,70	4,97	
33	97 4 180160	180/160	PN10	600,00	150,00	240,00	13,30	9,50	4,10	-
	97 5 180160		PN16				16,40	14,60	6,05	
34	97 4 020063	200/63	PN10	360,00	110,00	210,00	11,90	3,80	2,62	-
	97 5 020063		PN16				18,20	5,80	3,86	
35	97 4 020075	200/75	PN10	360,00	110,00	210,00	11,90	4,50	2,65	-
	97 5 020075		PN16				18,20	6,80	3,91	
36	97 4 020090	200/90	PN10	450,00	130,00	230,00	11,90	5,40	3,36	-
	97 5 020090		PN16				18,20	8,20	4,96	
37	97 4 200110	200/110	PN10	450,00	130,00	230,00	11,90	6,60	3,45	-
	97 5 200110		PN16				18,20	10,00	5,09	
38	97 4 200125	200/125	PN10	450,00	130,00	230,00	11,90	7,40	3,53	-
	97 5 200125		PN16				18,20	11,40	5,21	
39	97 4 200140	200/140	PN10	500,00	150,00	250,00	11,90	8,30	4,04	-
	97 5 200140		PN16				18,20	12,70	5,96	
40	97 4 200160	200/160	PN10	550,00	150,00	250,00	11,90	9,50	4,56	-
	97 5 200160		PN16				18,20	14,60	6,72	
41	97 4 200180	200/180	PN10	600,00	150,00	250,00	11,90	10,70	5,09	-
	97 5 200180		PN16				18,20	16,40	7,50	
42	97 4 022563	225/63	PN10	360,00	110,00	222,50	13,40	3,80	3,29	-
	97 5 022563		PN16				20,50	5,80	4,83	
43	97 4 022575	225/75	PN10	360,00	110,00	222,50	13,40	4,50	3,33	-
	97 5 022575		PN16				20,50	6,80	4,88	
44	97 4 022590	225/90	PN10	450,00	130,00	242,50	13,40	5,40	4,21	-
	97 5 022590		PN16				20,50	8,20	6,17	
45	97 4 225110	225/110	PN10	450,00	130,00	242,50	13,40	6,60	4,30	-
	97 5 225110		PN16				20,50	10,00	6,30	
46	97 4 225125	225/125	PN10	450,00	130,00	242,50	13,40	7,40	4,38	-
	97 5 225125		PN16				20,50	11,40	6,43	
47	97 4 225140	225/140	PN10	500,00	150,00	262,50	13,40	8,30	4,98	-
	97 5 225140		PN16				20,50	12,70	7,31	
48	97 4 225160	225/160	PN10	550,00	150,00	262,50	13,40	9,50	5,59	-
	97 5 225160		PN16				20,50	14,60	8,21	

water / gas

KONFEKSİYON İNEGAL TE - SEGMENTED REDUCED TEE - PE100 - SDR 17 - PN10 ve SDR 11 - PN16
TÉ RÉDUIT 90° SEGMENTÉ / НЕ РАВНОПРОХОДНОЙ ТРОЙНИК 90° (Сварной) / تي غير متساوية (ملففة)

water / gas

SIRA	ÜRÜN KODU	ÇAP d [mm]	BASINÇ [bar]	L [mm]	L ₁ [mm]	z [mm]	e [mm]	e ₁ [mm]	AĞIRLIK [kg]	KOLİ ADEDİ
SEQ	PRODUCT CODE	SIZE d [mm]	PRESSURE [bar]						WEIGHT [kg]	IN A PARCEL
49	97 4 225180	225/180	PN10	600,00	150,00	262,50	13,40	10,70	6,21	-
	97 5 225180		PN16				20,50	16,40	9,12	
50	97 4 225200	225/200	PN10	650,00	170,00	282,50	13,40	11,90	7,00	-
	97 5 225200		PN16				20,50	18,20	10,28	
51	97 4 025063	250/63	PN10	360,00	110,00	225,00	14,80	3,80	4,04	-
	97 5 025063		PN16				22,70	5,80	5,95	
52	97 4 025075	250/75	PN10	360,00	110,00	225,00	14,80	4,50	4,07	-
	97 5 025075		PN16				22,70	6,80	5,99	
53	97 4 025090	250/90	PN10	450,00	130,00	245,00	14,80	5,40	5,14	-
	97 5 025090		PN16				22,70	8,20	7,57	
54	97 4 250110	250/110	PN10	450,00	130,00	245,00	14,80	6,60	5,23	-
	97 5 250110		PN16				22,70	10,00	7,70	
55	97 4 250125	250/125	PN10	450,00	130,00	245,00	14,80	7,40	5,31	-
	97 5 250125		PN16				22,70	11,40	7,82	
56	97 4 250140	250/140	PN10	500,00	150,00	265,00	14,80	8,30	6,02	-
	97 5 250140		PN16				22,70	12,70	8,86	
57	97 4 250160	250/160	PN10	550,00	150,00	265,00	14,80	9,50	6,73	-
	97 5 250160		PN16				22,70	14,60	9,91	
58	97 4 250180	250/180	PN10	600,00	150,00	265,00	14,80	10,70	7,46	-
	97 5 250180		PN16				22,70	16,40	10,98	
59	97 4 250200	250/200	PN10	600,00	170,00	285,00	14,80	11,90	7,80	-
	97 5 250200		PN16				22,70	18,20	11,49	
60	97 4 250225	250/225	PN10	650,00	170,00	285,00	14,80	13,40	8,67	-
	97 5 250225		PN16				22,70	20,50	12,76	
61	97 4 028063	280/63	PN10	360,00	110,00	250,00	16,60	3,80	5,01	-
	97 5 028063		PN16				25,40	5,80	7,42	
62	97 4 028075	280/75	PN10	360,00	110,00	250,00	16,60	4,50	5,04	-
	97 5 028075		PN16				25,40	6,80	7,47	
63	97 4 028090	280/90	PN10	450,00	130,00	270,00	16,60	5,40	6,35	-
	97 5 028090		PN16				25,40	8,20	9,41	
64	97 4 280110	280/110	PN10	450,00	130,00	270,00	16,60	6,60	6,45	-
	97 5 280110		PN16				25,40	10,00	9,54	
65	97 4 280125	280/125	PN10	450,00	130,00	270,00	16,60	7,40	6,52	-
	97 5 280125		PN16				25,40	11,40	9,67	
66	97 4 280140	280/140	PN10	500,00	150,00	290,00	16,60	8,30	7,37	-
	97 5 280140		PN16				25,40	12,70	10,91	
67	97 4 280160	280/160	PN10	550,00	150,00	290,00	16,60	9,50	8,21	-
	97 5 280160		PN16				25,40	14,60	12,17	
68	97 4 280180	280/180	PN10	600,00	150,00	290,00	16,60	10,70	9,08	-
	97 5 280180		PN16				25,40	16,40	13,44	

"Yıldız bize, Biz Su'ya yön gösteriyoruz..."
 "The stars show us the way, we show way to the water..."

www.yildizpolietilen.com



KONFEKSİYON İNEGAL TE - SEGMENTED REDUCED TEE - PE100 - SDR 17 - PN10 ve SDR 11 - PN16
 TÉ RÉDUIT 90° SEGMENTÉ / НЕ РАВНОПРОХОДНОЙ ТРОЙНИК 90° (Сварной) / تي غير متساوية (ملففة)

SIRA	ÜRÜN KODU	ÇAP d [mm]	BASINÇ [bar]	L [mm]	L ₁ [mm]	z [mm]	e [mm]	e ₁ [mm]	AĞIRLIK [kg]	KOLİ ADEDİ
SEQ	PRODUCT CODE	SIZE d [mm]	PRESSURE [bar]						WEIGHT [kg]	IN A PARCEL
69	97 4 280200	280/200	PN10	600,00	170,00	310,00	16,60	11,90	9,42	-
	97 5 280200		PN16						13,95	
70	97 4 280225	280/225	PN10	650,00	170,00	310,00	16,60	13,40	10,42	-
	97 5 280225		PN16						15,42	
71	97 4 280250	280/250	PN10	700,00	170,00	310,00	16,60	14,80	11,46	-
	97 5 280250		PN16						16,96	
72	97 4 031590	315/90	PN10	450,00	130,00	287,50	18,70	5,40	8,02	-
	97 5 031590		PN16						11,80	
73	97 4 315110	315/110	PN10	450,00	130,00	287,50	18,70	6,60	8,11	-
	97 5 315110		PN16						11,93	
74	97 4 315125	315/125	PN10	450,00	130,00	287,50	18,70	7,40	8,19	-
	97 5 315125		PN16						12,05	
75	97 4 315140	315/140	PN10	500,00	150,00	307,50	18,70	8,30	9,22	-
	97 5 315140		PN16						13,56	
76	97 4 315160	315/160	PN10	550,00	150,00	307,50	18,70	9,50	10,25	-
	97 5 315160		PN16						15,08	
77	97 4 315180	315/180	PN10	600,00	150,00	307,50	18,70	10,70	11,30	-
	97 5 315180		PN16						16,62	
78	97 4 315200	315/200	PN10	600,00	170,00	327,50	18,70	11,90	11,64	-
	97 5 315200		PN16						17,13	
79	97 4 315225	315/225	PN10	650,00	170,00	327,50	18,70	13,40	12,83	-
	97 5 315225		PN16						18,87	
80	97 4 315250	315/250	PN10	650,00	170,00	327,50	18,70	14,80	13,18	-
	97 5 315250		PN16						19,39	
81	97 4 315280	315/280	PN10	700,00	170,00	327,50	18,70	16,60	14,51	-
	97 5 315280		PN16						21,37	
82	97 4 035590	355/90	PN10	450,00	130,00	307,50	21,20	5,40	9,68	-
	97 5 035590		PN16						14,90	
83	97 4 355110	355/110	PN10	450,00	130,00	307,50	21,20	6,60	9,78	-
	97 5 355110		PN16						15,03	
84	97 4 355125	355/125	PN10	450,00	130,00	307,50	21,20	7,40	9,85	-
	97 5 355125		PN16						15,16	
85	97 4 355140	355/140	PN10	500,00	150,00	327,50	21,20	8,30	11,07	-
	97 5 355140		PN16						17,01	
86	97 4 355160	355/160	PN10	550,00	150,00	327,50	21,20	9,50	12,28	-
	97 5 355160		PN16						18,88	
87	97 4 355180	355/180	PN10	600,00	150,00	327,50	21,20	10,70	13,52	-
	97 5 355180		PN16						20,76	
88	97 4 355200	355/200	PN10	600,00	170,00	347,50	21,20	11,90	13,86	-
	97 5 355200		PN16						21,27	

water / gas

KONFEKSİYON İNEGAL TE - SEGMENTED REDUCED TEE - PE100 - SDR 17 - PN10 ve SDR 11 - PN16
TÉ RÉDUIT 90° SEGMENTÉ / НЕ РАВНОПРОХОДНОЙ ТРОЙНИК 90° (Сварной) / تي غيرمتساوية (ملففة)

water / gas

SIRA	ÜRÜN KODU	ÇAP d [mm]	BASINÇ [bar]	L [mm]	L ₁ [mm]	z [mm]	e [mm]	e ₁ [mm]	AĞIRLIK [kg]	KOLİ ADEDİ
SEQ	PRODUCT CODE	SIZE d [mm]	PRESSURE [bar]						WEIGHT [kg]	IN A PARCEL
89	97 4 355225	355/225	PN10	650,00	170,00	347,50	21,20	13,40	15,23	-
	97 5 355225		PN16				32,20	20,50	23,35	
90	97 4 355250	355/250	PN10	650,00	170,00	347,50	21,20	14,80	15,59	-
	97 5 355250		PN16				32,20	22,70	23,88	
91	97 4 355280	355/280	PN10	700,00	170,00	347,50	21,20	16,60	17,10	-
	97 5 355280		PN16				32,20	25,40	26,20	
92	97 4 355315	355/315	PN10	800,00	170,00	347,50	21,20	18,70	19,84	-
	97 5 355315		PN16				32,20	28,60	30,35	
93	97 4 040090	400/90	PN10	450,00	130,00	330,00	23,70	5,40	12,79	-
	97 5 040090		PN16				36,30	8,20	18,86	
94	97 4 400110	400/110	PN10	450,00	130,00	330,00	23,70	6,60	12,88	-
	97 5 400110		PN16				36,30	10,00	18,99	
95	97 4 400125	400/125	PN10	450,00	130,00	330,00	23,70	7,40	12,96	-
	97 5 400125		PN16				36,30	11,40	19,12	
96	97 4 400140	400/140	PN10	500,00	150,00	350,00	23,70	8,30	14,52	-
	97 5 400140		PN16				36,30	12,70	21,41	
97	97 4 400160	400/160	PN10	550,00	150,00	350,00	23,70	9,50	16,08	-
	97 5 400160		PN16				36,30	14,60	23,72	
98	97 4 400180	400/180	PN10	600,00	150,00	350,00	23,70	10,70	17,66	-
	97 5 400180		PN16				36,30	16,40	26,04	
99	97 4 400200	400/200	PN10	600,00	170,00	370,00	23,70	11,90	18,00	-
	97 5 400200		PN16				36,30	18,20	26,55	
100	97 4 400225	400/225	PN10	650,00	170,00	370,00	23,70	13,40	19,72	-
	97 5 400225		PN16				36,30	20,50	29,07	
101	97 4 400250	400/250	PN10	650,00	170,00	370,00	23,70	14,80	20,07	-
	97 5 400250		PN16				36,30	22,70	29,60	
102	97 4 400280	400/280	PN10	700,00	170,00	370,00	23,70	16,60	21,93	-
	97 5 400280		PN16				36,30	25,40	32,36	
103	97 4 400315	400/315	PN10	750,00	170,00	370,00	23,70	18,70	23,96	-
	97 5 400315		PN16				36,30	28,60	35,33	
104	97 4 400355	400/355	PN10	850,00	170,00	370,00	23,70	21,10	27,56	-
	97 5 400355		PN16				36,30	32,20	40,63	
105	97 4 045090	450/90	PN10	450,00	130,00	355,00	26,70	5,40	16,12	-
	97 5 045090		PN16				40,90	8,20	23,81	
106	97 4 450110	450/110	PN10	450,00	130,00	355,00	26,70	6,60	16,21	-
	97 5 450110		PN16				40,90	10,00	23,94	
107	97 4 450125	450/125	PN10	500,00	130,00	355,00	26,70	7,40	18,06	-
	97 5 450125		PN16				40,90	11,40	26,68	
108	97 4 450140	450/140	PN10	500,00	150,00	375,00	26,70	8,30	18,22	-
	97 5 450140		PN16				40,90	12,70	26,91	

"Yıldız bize, Biz Su'ya yön gösteriyoruz..."
 "The stars show us the way, we show way to the water..."

www.yildizpolietilen.com



KONFEKSİYON İNEGAL TE - SEGMENTED REDUCED TEE - PE100 - SDR 17 - PN10 ve SDR 11 - PN16
 TÉ RÉDUIT 90° SEGMENTÉ / НЕ РАВНОПРОХОДНОЙ ТРОЙНИК 90° (Сварной) / تي غيرمتساوية (ملففة)

SIRA	ÜRÜN KODU	ÇAP d [mm]	BASINÇ [bar]	L [mm]	L ₁ [mm]	z [mm]	e [mm]	e ₁ [mm]	AĞIRLIK [kg]	KOLİ ADEDİ
SEQ	PRODUCT CODE	SIZE d [mm]	PRESSURE [bar]						WEIGHT [kg]	IN A PARCEL
109	97 4 450160	450/160	PN10	550,00	150,00	375,00	26,70	9,50	20,15	-
	97 5 450160		PN16				40,90	14,60	29,77	
110	97 4 450180	450/180	PN10	550,00	150,00	375,00	26,70	10,70	20,33	-
	97 5 450180		PN16				40,90	16,40	30,03	
111	97 4 450200	450/200	PN10	600,00	170,00	395,00	26,70	11,90	22,44	-
	97 5 450200		PN16				40,90	18,20	33,15	
112	97 4 450225	450/225	PN10	650,00	170,00	395,00	26,70	13,40	24,53	-
	97 5 450225		PN16				40,90	20,50	36,22	
113	97 4 450250	450/250	PN10	650,00	170,00	395,00	26,70	14,80	24,88	-
	97 5 450250		PN16				40,90	22,70	36,75	
114	97 4 450280	450/280	PN10	700,00	170,00	395,00	26,70	16,60	27,11	-
	97 5 450280		PN16				40,90	25,40	40,06	
115	97 4 450315	450/315	PN10	750,00	170,00	395,00	26,70	18,70	29,51	-
	97 5 450315		PN16				40,90	28,60	43,58	
116	97 4 450355	450/355	PN10	800,00	170,00	395,00	26,70	21,10	32,08	-
	97 5 450355		PN16				40,90	32,20	47,37	
117	97 4 450400	450/400	PN10	900,00	185,00	410,00	26,70	23,70	37,04	-
	97 5 450400		PN16				40,90	36,30	54,71	
118	97 4 050090	500/90	PN10	450,00	130,00	380,00	29,70	5,40	19,90	-
	97 5 050090		PN16				45,40	8,20	29,30	
119	97 4 500110	500/110	PN10	450,00	130,00	380,00	29,70	6,60	19,99	-
	97 5 500110		PN16				45,40	10,00	29,43	
120	97 4 500125	500/125	PN10	450,00	130,00	380,00	29,70	7,40	20,07	-
	97 5 500125		PN16				45,40	11,40	29,56	
121	97 4 500140	500/140	PN10	500,00	150,00	400,00	29,70	8,30	22,42	-
	97 5 500140		PN16				45,40	12,70	33,01	
122	97 4 500160	500/160	PN10	550,00	150,00	400,00	29,70	9,50	24,77	-
	97 5 500160		PN16				45,40	14,60	36,48	
123	97 4 500180	500/180	PN10	550,00	150,00	400,00	29,70	10,70	24,95	-
	97 5 500180		PN16				45,40	16,40	36,74	
124	97 4 500200	500/200	PN10	600,00	170,00	420,00	29,70	11,90	27,48	-
	97 5 500200		PN16				45,40	18,20	40,47	
125	97 4 500225	500/225	PN10	650,00	170,00	420,00	29,70	13,40	29,99	-
	97 5 500225		PN16				45,40	20,50	44,15	
126	97 4 500250	500/250	PN10	650,00	170,00	420,00	29,70	14,80	30,34	-
	97 5 500250		PN16				45,40	22,70	44,68	
127	97 4 500280	500/280	PN10	700,00	170,00	420,00	29,70	16,60	32,99	-
	97 5 500280		PN16				45,40	25,40	48,60	
128	97 4 500315	500/315	PN10	750,00	170,00	420,00	29,70	18,70	35,81	-
	97 5 500315		PN16				45,40	28,60	52,73	

water / gas

KONFEKSİYON İNEGAL TE - SEGMENTED REDUCED TEE - PE100 - SDR 17 - PN10 ve SDR 11 - PN16
TÉ RÉDUIT 90° SEGMENTÉ / НЕ РАВНОПРОХОДНОЙ ТРОЙНИК 90° (Сварной) / تي غيرمتساوية (ملفقة)

SIRA	ÜRÜN KODU	ÇAP d [mm]	BASINÇ [bar]	L [mm]	L ₁ [mm]	z [mm]	e [mm]	e ₁ [mm]	AĞIRLIK [kg]	KOLİ ADEDİ
SEQ	PRODUCT CODE	SIZE d [mm]	PRESSURE [bar]						WEIGHT [kg]	IN A PARCEL
129	97 4 500355	500/355	PN10	800,00	170,00	420,00	29,70	21,10	38,80	-
	97 5 500355		PN16						57,13	
130	97 4 500400	500/400	PN10	850,00	200,00	450,00	29,70	23,70	42,83	-
	97 5 500400		PN16						63,09	
131	97 4 500450	500/450	PN10	1000,00	200,00	450,00	29,70	26,70	50,88	-
	97 5 500450		PN16						74,96	
132	97 4 056090	560/90	PN10	450,00	130,00	390,00	33,20	5,40	24,85	-
	97 5 056090		PN16						36,64	
133	97 4 560110	560/110	PN10	450,00	130,00	390,00	33,20	6,60	24,94	-
	97 5 560110		PN16						36,77	
134	97 4 560125	560/125	PN10	500,00	130,00	390,00	33,20	7,40	27,76	-
	97 5 560125		PN16						40,93	
135	97 4 560140	560/140	PN10	500,00	150,00	410,00	33,20	8,30	27,92	-
	97 5 560140		PN16						41,16	
136	97 4 560160	560/160	PN10	550,00	150,00	410,00	33,20	9,50	30,82	-
	97 5 560160		PN16						45,44	
137	97 4 560180	560/180	PN10	550,00	150,00	410,00	33,20	10,70	31,00	-
	97 5 560180		PN16						45,70	
138	97 4 560200	560/200	PN10	600,00	170,00	430,00	33,20	11,90	34,08	-
	97 5 560200		PN16						50,25	
139	97 4 560225	560/225	PN10	650,00	170,00	430,00	33,20	13,40	37,14	-
	97 5 560225		PN16						54,75	
140	97 4 560250	560/250	PN10	650,00	170,00	430,00	33,20	14,80	37,49	-
	97 5 560250		PN16						55,27	
141	97 4 560280	560/280	PN10	700,00	170,00	430,00	33,20	16,60	40,69	-
	97 5 560280		PN16						60,01	
142	97 4 560315	560/315	PN10	750,00	170,00	430,00	33,20	18,70	44,06	-
	97 5 560315		PN16						64,95	
143	97 4 560355	560/355	PN10	800,00	170,00	430,00	33,20	21,10	47,60	-
	97 5 560355		PN16						70,17	
144	97 4 560400	560/400	PN10	850,00	200,00	460,00	33,20	23,70	52,18	-
	97 5 560400		PN16						76,94	
145	97 4 560450	560/450	PN10	900,00	200,00	460,00	33,20	26,70	56,40	-
	97 5 560450		PN16						83,18	
146	97 4 560500	560/500	PN10	1100,00	200,00	460,00	33,20	29,70	69,04	-
	97 5 560500		PN16						101,78	
147	97 4 063090	630/90	PN10	450,00	130,00	445,00	37,40	5,40	31,42	-
	97 5 063090		PN16						46,18	
148	97 4 630110	630/110	PN10	450,00	130,00	445,00	37,40	6,60	31,51	-
	97 5 630110		PN16						46,31	

water / gas

"Yıldız bize, Biz Su'ya yön gösteriyoruz..."
 "The stars show us the way, we show way to the water..."

www.yildizpolietilen.com



KONFEKSİYON İNEGAL TE - SEGMENTED REDUCED TEE - PE100 - SDR 17 - PN10 ve SDR 11 - PN16
 TÉ RÉDUIT 90° SEGMENTÉ / НЕ РАВНОПРОХОДНОЙ ТРОЙНИК 90° (Сварной) / تي غيرمتساوية (ملففة)

SIRA	ÜRÜN KODU	ÇAP d [mm]	BASINÇ [bar]	L [mm]	L ₁ [mm]	z [mm]	e [mm]	e ₁ [mm]	AĞIRLIK [kg]	KOLİ ADEDİ
SEQ	PRODUCT CODE	SIZE d [mm]	PRESSURE [bar]						WEIGHT [kg]	IN A PARCEL
149	97 4 630125	630/125	PN10	450,00	130,00	445,00	37,40	7,40	31,59	-
	97 5 630125		PN16						46,43	
150	97 4 630140	630/140	PN10	500,00	150,00	465,00	37,40	8,30	35,22	-
	97 5 630140		PN16						51,76	
151	97 4 630160	630/160	PN10	550,00	150,00	465,00	37,40	9,50	38,85	-
	97 5 630160		PN16						57,10	
152	97 4 630180	630/180	PN10	550,00	150,00	465,00	37,40	10,70	39,03	-
	97 5 630180		PN16						57,36	
153	97 4 630200	630/200	PN10	600,00	170,00	485,00	37,40	11,90	42,84	-
	97 5 630200		PN16						62,97	
154	97 4 630225	630/225	PN10	600,00	170,00	485,00	37,40	13,40	43,16	-
	97 5 630225		PN16						63,43	
155	97 4 630250	630/250	PN10	650,00	170,00	485,00	37,40	14,80	46,98	-
	97 5 630250		PN16						69,05	
156	97 4 630280	630/280	PN10	650,00	170,00	485,00	37,40	16,60	47,44	-
	97 5 630280		PN16						69,75	
157	97 4 630315	630/315	PN10	750,00	170,00	485,00	37,40	18,70	55,01	-
	97 5 630315		PN16						80,85	
158	97 4 630355	630/355	PN10	800,00	170,00	485,00	37,40	21,10	59,28	-
	97 5 630355		PN16						87,13	
159	97 4 630400	630/400	PN10	850,00	200,00	515,00	37,40	23,70	64,59	-
	97 5 630400		PN16						94,96	
160	97 4 630450	630/450	PN10	850,00	200,00	515,00	37,40	26,70	66,07	-
	97 5 630450		PN16						97,16	
161	97 4 630500	630/500	PN10	900,00	200,00	515,00	37,40	29,70	71,22	-
	97 5 630500		PN16						104,70	
162	97 4 630560	630/560	PN10	1050,00	220,00	535,00	37,40	33,20	84,93	-
	97 5 630560		PN16						124,88	
163	97 4 710110	710/110	PN10	450,00	130,00	485,00	42,10	6,60	39,93	-
	97 5 710110		PN16						58,91	
164	97 4 710125	710/125	PN10	500,00	130,00	485,00	42,10	7,40	44,41	-
	97 5 710125		PN16						65,53	
165	97 4 710140	710/140	PN10	500,00	150,00	505,00	42,10	8,30	44,57	-
	97 5 710140		PN16						65,76	
166	97 4 710160	710/160	PN10	550,00	150,00	505,00	42,10	9,50	49,13	-
	97 5 710160		PN16						72,50	
167	97 4 710180	710/180	PN10	550,00	150,00	505,00	42,10	10,70	49,31	-
	97 5 710180		PN16						72,76	
168	97 4 710200	710/200	PN10	600,00	170,00	525,00	42,10	11,90	54,06	-
	97 5 710200		PN16						79,77	

water / gas

KONFEKSİYON İNEGAL TE - SEGMENTED REDUCED TEE - PE100 - SDR 17 - PN10 ve SDR 11 - PN16
TÉ RÉDUIT 90° SEGMENTÉ / НЕ РАВНОПРОХОДНОЙ ТРОЙНИК 90° (Сварной) / تي غير متساوية ملفقة

water / gas

SIRA	ÜRÜN KODU	ÇAP d [mm]	BASINÇ [bar]	L [mm]	L ₁ [mm]	z [mm]	e [mm]	e ₁ [mm]	AĞIRLIK [kg]	KOLİ ADEDİ
SEQ	PRODUCT CODE	SIZE d [mm]	PRESSURE [bar]						WEIGHT [kg]	IN A PARCEL
169	97 4 710225	710/225	PN10	650,00	170,00	525,00	42,10	13,40	58,78	-
	97 5 710225		PN16						86,73	
170	97 4 710250	710/250	PN10	650,00	170,00	525,00	42,10	14,80	59,14	-
	97 5 710250		PN16						87,25	
171	97 4 710280	710/280	PN10	700,00	170,00	525,00	42,10	16,60	64,00	-
	97 5 710280		PN16						94,45	
172	97 4 710315	710/315	PN10	750,00	170,00	525,00	42,10	18,70	69,03	-
	97 5 710315		PN16						101,85	
173	97 4 710355	710/355	PN10	800,00	170,00	525,00	42,10	21,10	74,24	-
	97 5 710355		PN16						109,53	
174	97 4 710400	710/400	PN10	850,00	200,00	555,00	42,10	23,70	80,49	-
	97 5 710400		PN16						118,76	
175	97 4 710450	710/450	PN10	900,00	200,00	555,00	42,10	26,70	86,37	-
	97 5 710450		PN16						127,46	
176	97 4 710500	710/500	PN10	1000,00	200,00	555,00	42,10	29,70	96,86	-
	97 5 710500		PN16						142,90	
177	97 4 710560	710/560	PN10	1050,00	220,00	575,00	42,10	33,20	104,56	-
	97 5 710560		PN16						154,28	
178	97 4 710630	710/630	PN10	1100,00	220,00	575,00	42,10	37,40	112,18	-
	97 5 710630		PN16						165,44	
179	97 4 800110	800/110	PN10	450,00	130,00	530,00	47,40	6,60	50,68	-
	97 5 800110		PN16						76,46	
180	97 4 800125	800/125	PN10	500,00	130,00	530,00	47,40	7,40	56,36	-
	97 5 800125		PN16						85,03	
181	97 4 800140	800/140	PN10	500,00	150,00	550,00	47,40	8,30	56,52	-
	97 5 800140		PN16						85,26	
182	97 4 800160	800/160	PN10	550,00	150,00	550,00	47,40	9,50	62,28	-
	97 5 800160		PN16						93,95	
183	97 4 800180	800/180	PN10	550,00	150,00	550,00	47,40	10,70	62,46	-
	97 5 800180		PN16						94,21	
184	97 4 800200	800/200	PN10	600,00	170,00	570,00	47,40	11,90	68,40	-
	97 5 800200		PN16						103,17	
185	97 4 800225	800/225	PN10	650,00	170,00	570,00	47,40	13,40	74,32	-
	97 5 800225		PN16						112,08	
186	97 4 800250	800/250	PN10	650,00	170,00	570,00	47,40	14,80	74,67	-
	97 5 800250		PN16						112,60	
187	97 4 800280	800/280	PN10	700,00	170,00	570,00	47,40	16,60	80,73	-
	97 5 800280		PN16						121,75	
188	97 4 800315	800/315	PN10	750,00	170,00	570,00	47,40	18,70	86,96	-
	97 5 800315		PN16						131,10	

"Yıldız bize, Biz Su'ya yön gösteriyoruz..."
 "The stars show us the way, we show way to the water..."

www.yildizpolietilen.com



KONFEKSİYON İNEGAL TE - SEGMENTED REDUCED TEE - PE100 - SDR 17 - PN10 ve SDR 11 - PN16
 TÉ RÉDUIT 90° SEGMENTÉ / НЕ РАВНОПРОХОДНОЙ ТРОЙНИК 90° (Сварной) / تي غير متساوية ملفقة

SIRA	ÜRÜN KODU	ÇAP d [mm]	BASINÇ [bar]	L [mm]	L ₁ [mm]	z [mm]	e [mm]	e ₁ [mm]	AĞIRLIK [kg]	KOLİ ADEDİ
SEQ	PRODUCT CODE	SIZE d [mm]	PRESSURE [bar]						WEIGHT [kg]	IN A PARCEL
189	97 4 800355	800/355	PN10	800,00	170,00	570,00	47,40	21,10	93,36	-
	97 5 800355		PN16				72,80	32,20	140,73	
190	97 4 800400	800/400	PN10	850,00	200,00	600,00	47,40	23,70	100,80	-
	97 5 800400		PN16				72,80	36,30	151,91	
191	97 4 800450	800/450	PN10	900,00	200,00	600,00	47,40	26,70	107,88	-
	97 5 800450		PN16				72,80	40,90	162,56	
192	97 4 800500	800/500	PN10	1000,00	200,00	600,00	47,40	29,70	120,76	-
	97 5 800500		PN16				72,80	45,40	181,90	
193	97 4 800560	800/560	PN10	1050,00	220,00	620,00	47,40	33,20	129,66	-
	97 5 800560		PN16				72,80	50,80	195,23	
194	97 4 800630	800/630	PN10	1100,00	220,00	620,00	47,40	37,40	138,47	-
	97 5 800630		PN16				72,80	57,20	208,34	
195	97 4 800710	800/710	PN10	1200,00	220,00	620,00	47,40	42,10	153,78	-
	97 5 800710		PN16				72,80	64,50	231,40	
196	97 4 900110	900/110	PN10	450,00	130,00	580,00	53,30	6,60	63,73	-
	97 5 900110		PN16				81,70	10,00	94,91	
197	97 4 900125	900/125	PN10	450,00	130,00	580,00	53,30	7,40	63,81	-
	97 5 900125		PN16				81,70	11,40	95,03	
198	97 4 900140	900/140	PN10	500,00	150,00	600,00	53,30	8,30	71,02	-
	97 5 900140		PN16				81,70	12,70	105,76	
199	97 4 900160	900/160	PN10	550,00	150,00	600,00	53,30	9,50	78,23	-
	97 5 900160		PN16				81,70	14,60	116,50	
200	97 4 900180	900/180	PN10	550,00	150,00	600,00	53,30	10,70	78,41	-
	97 5 900180		PN16				81,70	16,40	116,76	
201	97 4 900200	900/200	PN10	600,00	170,00	620,00	53,30	11,90	85,80	-
	97 5 900200		PN16				81,70	18,20	127,77	
202	97 4 900225	900/225	PN10	650,00	170,00	620,00	53,30	13,40	93,17	-
	97 5 900225		PN16				81,70	20,50	138,73	
203	97 4 900250	900/250	PN10	650,00	170,00	620,00	53,30	14,80	93,52	-
	97 5 900250		PN16				81,70	22,70	139,25	
204	97 4 900280	900/280	PN10	700,00	170,00	620,00	53,30	16,60	101,03	-
	97 5 900280		PN16				81,70	25,40	150,45	
205	97 4 900315	900/315	PN10	750,00	170,00	620,00	53,30	18,70	108,71	-
	97 5 900315		PN16				81,70	28,60	161,85	
206	97 4 900350	900/350	PN10	800,00	170,00	620,00	53,30	21,10	116,56	-
	97 5 900350		PN16				81,70	32,20	173,53	
207	97 4 900400	900/400	PN10	850,00	200,00	650,00	53,30	23,70	125,45	-
	97 5 900400		PN16				81,70	36,30	186,76	
208	97 4 900450	900/450	PN10	900,00	200,00	650,00	53,30	26,70	133,98	-
	97 5 900450		PN16				81,70	40,90	199,46	

water / gas

KONFEKSİYON İNEGAL TE - SEGMENTED REDUCED TEE - PE100 - SDR 17 - PN10 ve SDR 11 - PN16
TÉ RÉDUIT 90° SEGMENTÉ / НЕ РАВНОПРОХОДНОЙ ТРОЙНИК 90° (Сварной) / تي غيرمتساوية (ملفقة)

water / gas

SIRA	ÜRÜN KODU	ÇAP d [mm]	BASINÇ [bar]	L [mm]	L ₁ [mm]	z [mm]	e [mm]	e ₁ [mm]	AĞIRLIK [kg]	KOLİ ADEDİ
SEQ	PRODUCT CODE	SIZE d [mm]	PRESSURE [bar]	L [mm]	L ₁ [mm]	z [mm]	e [mm]	e ₁ [mm]	WEIGHT [kg]	IN A PARCEL
209	97 4 900500	900/500	PN10	1000,00	200,00	650,00	53,30	29,70	149,76	-
	97 5 900500		PN16				81,70	45,40	222,90	
210	97 4 900560	900/560	PN10	1050,00	220,00	670,00	53,30	33,20	160,11	-
	97 5 900560		PN16				81,70	50,80	238,28	
211	97 4 900630	900/630	PN10	1100,00	220,00	670,00	53,30	37,40	170,37	-
	97 5 900630		PN16				81,70	57,20	253,44	
212	97 4 900710	900/710	PN10	1200,00	220,00	670,00	53,30	42,10	188,58	-
	97 5 900710		PN16				81,70	64,50	280,60	
213	97 4 900800	900/800	PN10	1300,00	220,00	670,00	53,30	47,40	207,94	-
	97 5 900800		PN16				81,70	72,80	310,18	
214	97 4 990110	1000/110	PN10	450,00	130,00	630,00	59,30	6,60	79,03	-
	97 5 990110		PN16				90,80	10,00	116,96	
215	97 4 990125	1000/125	PN10	450,00	130,00	630,00	59,30	7,40	79,11	-
	97 5 990125		PN16				90,80	11,40	117,08	
216	97 4 990140	1000/140	PN10	500,00	150,00	650,00	59,30	8,30	88,02	-
	97 5 990140		PN16				90,80	12,70	130,26	
217	97 4 990160	1000/160	PN10	550,00	150,00	650,00	59,30	9,50	96,93	-
	97 5 990160		PN16				90,80	14,60	143,45	
218	97 4 990180	1000/180	PN10	550,00	150,00	650,00	59,30	10,70	97,11	-
	97 5 990180		PN16				90,80	16,40	143,71	
219	97 4 990200	1000/200	PN10	600,00	170,00	670,00	59,30	11,90	106,20	-
	97 5 990200		PN16				90,80	18,20	157,17	
220	97 4 990225	1000/225	PN10	650,00	170,00	670,00	59,30	13,40	115,27	-
	97 5 990225		PN16				90,80	20,50	170,58	
221	97 4 990250	1000/250	PN10	650,00	170,00	670,00	59,30	14,80	115,62	-
	97 5 990250		PN16				90,80	22,70	171,10	
222	97 4 990280	1000/280	PN10	700,00	170,00	670,00	59,30	16,60	124,83	-
	97 5 990280		PN16				90,80	25,40	184,75	
223	97 4 990315	1000/315	PN10	750,00	170,00	670,00	59,30	18,70	134,21	-
	97 5 990315		PN16				90,80	28,60	198,60	
224	97 4 990355	1000/355	PN10	800,00	170,00	670,00	59,30	21,10	143,76	-
	97 5 990355		PN16				90,80	32,20	212,73	
225	97 4 990400	1000/400	PN10	850,00	200,00	700,00	59,30	23,70	154,35	-
	97 5 990400		PN16				90,80	36,30	228,41	
226	97 4 990450	1000/450	PN10	850,00	200,00	700,00	59,30	26,70	155,83	-
	97 5 990450		PN16				90,80	40,90	230,61	
227	97 4 990500	1000/500	PN10	1000,00	200,00	700,00	59,30	29,70	183,76	-
	97 5 990500		PN16				90,80	45,40	271,90	
228	97 4 990560	1000/560	PN10	1050,00	220,00	720,00	59,30	33,20	195,81	-
	97 5 990560		PN16				90,80	50,80	289,73	

"Yıldız bize, Biz Su'ya yön gösteriyoruz..."
 "The stars show us the way, we show way to the water..."

www.yildizpolietilen.com



KONFEKSİYON İNEGAL TE - SEGMENTED REDUCED TEE - PE100 - SDR 17 - PN10 ve SDR 11 - PN16
 TÉ RÉDUIT 90° SEGMENTÉ / НЕ РАВНОПРОХОДНОЙ ТРОЙНИК 90° (Сварной) / تي غير متساوية ملفقة

SIRA	ÜRÜN KODU	ÇAP d [mm]	BASINÇ [bar]	L [mm]	L ₁ [mm]	z [mm]	e [mm]	e ₁ [mm]	AĞIRLIK [kg]	KOLİ ADEDİ
SEQ	PRODUCT CODE	SIZE d [mm]	PRESSURE [bar]						WEIGHT [kg]	IN A PARCEL
229	97 4 990630	1000/630	PN10	1100,00	220,00	720,00	59,30	37,40	207,77	-
	97 5 990630		PN16				90,80	57,20	307,34	
230	97 4 990710	1000/710	PN10	1200,00	220,00	720,00	59,30	42,10	229,38	-
	97 5 990710		PN16				90,80	64,50	339,40	
231	97 4 990800	1000/800	PN10	1300,00	220,00	720,00	59,30	47,40	252,14	-
	97 5 990800		PN16				90,80	72,80	373,88	
232	97 4 990900	1000/900	PN10	1450,00	220,00	720,00	59,30	53,30	284,77	-
	97 5 990900		PN16				90,80	81,70	421,75	
233	97 4 988110	1200/110	PN10	500,00	130,00	730,00	70,60	6,60	127,78	-
	97 5 988110		PN16				-	10,00	-	
234	97 4 988125	1200/125	PN10	500,00	130,00	730,00	70,60	7,40	127,86	-
	97 5 988125		PN16				-	11,40	-	
235	97 4 988140	1200/140	PN10	550,00	150,00	750,00	70,60	8,30	140,77	-
	97 5 988140		PN16				-	12,70	-	
236	97 4 988160	1200/160	PN10	600,00	150,00	750,00	70,60	9,50	153,68	-
	97 5 988160		PN16				-	14,60	-	
237	97 4 988180	1200/180	PN10	600,00	150,00	750,00	70,60	10,70	153,86	-
	97 5 988180		PN16				-	16,40	-	
238	97 4 988200	1200/200	PN10	650,00	170,00	770,00	70,60	11,90	166,95	-
	97 5 988200		PN16				-	18,20	-	
239	97 4 988225	1200/225	PN10	700,00	170,00	770,00	70,60	13,40	180,02	-
	97 5 988225		PN16				-	20,50	-	
240	97 4 988250	1200/250	PN10	700,00	170,00	770,00	70,60	14,80	180,37	-
	97 5 988250		PN16				-	22,70	-	
241	97 4 988280	1200/280	PN10	750,00	170,00	770,00	70,60	16,60	193,58	-
	97 5 988280		PN16				-	25,40	-	
242	97 4 988315	1200/315	PN10	800,00	170,00	770,00	70,60	18,70	206,96	-
	97 5 988315		PN16				-	28,60	-	
243	97 4 988355	1200/355	PN10	900,00	170,00	770,00	70,60	21,10	233,26	-
	97 5 988355		PN16				-	32,20	-	
244	97 4 988400	1200/400	PN10	950,00	200,00	800,00	70,60	23,70	247,85	-
	97 5 988400		PN16				-	36,30	-	
245	97 4 988450	1200/450	PN10	1000,00	200,00	800,00	70,60	26,70	262,08	-
	97 5 988450		PN16				-	40,90	-	
246	97 4 988500	1200/500	PN10	1050,00	200,00	800,00	70,60	29,70	276,51	-
	97 5 988500		PN16				-	45,40	-	
247	97 4 988560	1200/560	PN10	1100,00	220,00	820,00	70,60	33,20	292,56	-
	97 5 988560		PN16				-	50,80	-	
248	97 4 988630	1200/630	PN10	1150,00	220,00	820,00	70,60	37,40	308,52	-
	97 5 988630		PN16				-	57,20	-	

water / gas

KONFEKSİYON İNEĞAL TE - SEGMENTED REDUCED TEE - PE100 - SDR 17 - PN10 ve SDR 11 - PN16
TÉ RÉDUIT 90° SEGMENTÉ / НЕ РАВНОПРОХОДНОЙ ТРОЙНИК 90° (Сварной) / تي غير متساوية (ملففة)

SIRA	ÜRÜN KODU	ÇAP d [mm]	BASINÇ [bar]	L [mm]	L ₁ [mm]	z [mm]	e [mm]	e ₁ [mm]	AĞIRLIK [kg]	KOLİ ADEDİ
SEQ.	PRODUCT CODE	SIZE d [mm]	PRESSURE [bar]						WEIGHT [kg]	IN A PARCEL
249	97 4 988710	1200/710	PN10	1250,00	220,00	820,00	70,60	42,10	338,13	-
	97 5 988710		PN16				-	64,50	-	
250	97 4 988800	1200/800	PN10	1350,00	220,00	820,00	70,60	47,40	368,89	-
	97 5 988800		PN16				-	72,80	-	
251	97 4 988900	1200/900	PN10	1500,00	220,00	820,00	70,60	53,30	413,52	-
	97 5 988900		PN16				-	-	-	
252	97 4 988990	1200/1000	PN10	1600,00	220,00	820,00	70,60	59,30	446,50	-
	97 5 988990		PN16				-	-	-	

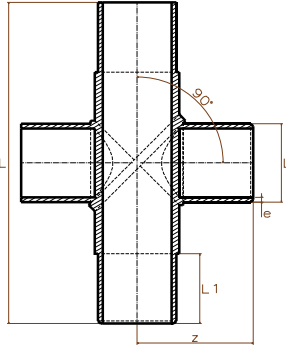

KİT ENJEKSİYON KAYNAKLI DÖRT KÖŞE TE
KIT INJECTION WELDED CROSS TEE
PE100 - SDR 17 - PN10 ve SDR 11 - PN16

CROIX TÉ 90° INJECTÉ (KIT) / КРЕСТОВИНА 90° (приварной литой) / تي صليبية متساوية (حقن)

SIRA	ÜRÜN KODU	ÇAP d [mm]	BASINÇ [bar]	L [mm]	z [mm]	L ₁ [mm]	e [mm]	AĞIRLIK [kg]	KOLİ ADEDİ	KOLİ EBATI
SEQ.	PRODUCT CODE	SIZE d [mm]	PRESSURE [bar]					WEIGHT [kg]	IN A PARCEL	PCS PRICE
1	97 1 210032	32	PN10	173,00	80,00	45,00	2,30	0,08	-	-
	97 2 210032		PN16				3,00	0,13		
2	97 1 210040	40	PN10	186,00	96,30	53,00	2,80	0,13	-	-
	97 2 210040		PN16				4,05	0,19		
3	97 1 210050	50	PN10	214,00	111,20	60,30	3,40	0,24	-	-
	97 2 210050		PN16				4,80	0,36		
4	97 1 210063	63	PN10	247,00	121,90	65,00	4,12	0,40	-	-
	97 2 210063		PN16				6,37	0,60		
5	97 1 210075	75	PN10	277,30	133,30	69,80	4,79	0,63	-	-
	97 2 210075		PN16				7,40	0,94		
6	97 1 210090	90	PN10	288,70	148,00	80,00	5,80	0,90	-	-
	97 2 210090		PN16				9,20	1,35		
7	97 1 210110	110	PN10	343,00	165,90	89,50	6,60	1,62	-	-
	97 2 210110		PN16				10,20	1,83		
8	97 1 210125	125	PN10	374,00	192,50	100,90	8,15	2,02	-	-
	97 2 210125		PN16				12,60	3,03		
9	97 1 210140	140	PN10	358,00	182,00	93,00	8,54	2,06	-	-
	97 2 210140		PN16				13,20	3,10		
10	97 1 210160	160	PN10	485,00	214,00	109,10	10,60	4,14	-	-
	97 2 210160		PN16				14,65	5,68		

"Yıldız bize, Biz Su'ya yön gösteriyoruz..."
"The stars show us the way, we show way to the water..."

www.yildizpolietilen.com



KİT ENJEKSİYON KAYNAKLI DÖRT KÖŞE TE - KIT INJECTION WELDED CROSS TEE
CROIX TÉ 90° INJECTÉ (KIT) / КРЕСТОВИНА 90° (приварной литой) / تي صليبية متساوية (حقن)
PE100 - SDR17 - PN10 ve SDR11 - PN16

SIRA	ÜRÜN KODU	ÇAP d [mm]	BASINÇ [bar]	L [mm]	z [mm]	L ₁ [mm]	e [mm]	AĞIRLIK [kg]	KOLİ ADEDİ	KOLİ EBATI
SEQ.	PRODUCT CODE	SIZE d [mm]	PRESSURE [bar]	L [mm]	z [mm]	L ₁ [mm]	e [mm]	WEIGHT [kg]	IN A PARCEL	PCS PRICE
11	97 1 210180	180	PN10	515,00	232,00	113,96	10,80	4,82	-	-
	97 2 210180		PN16				16,50	7,22		
12	97 1 210200	200	PN10	505,00	243,00	122,30	11,70	6,96	-	-
	97 2 210200		PN16				18,70	9,40		
13	97 1 210225	225	PN10	533,00	251,50	121,70	13,50	7,88	-	-
	97 2 210225		PN16				20,60	10,86		
14	97 1 210250	250	PN10	583,00	284,00	132,45	20,50	13,60	-	-
	97 2 210250		PN16				23,20	15,65		
15	97 1 210315	315	PN10	715,00	337,50	152,65	20,70	21,50	-	-
	97 2 210315		PN16				31,20	32,25		

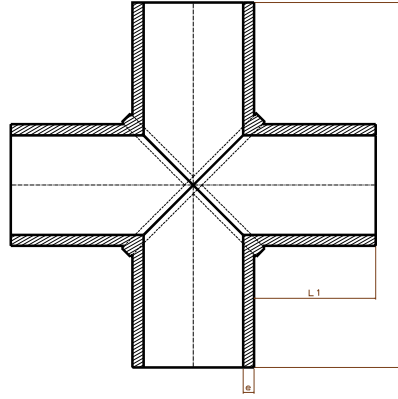
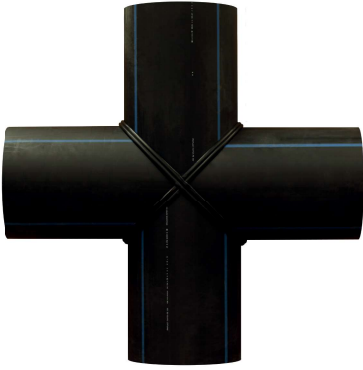

KONFEKSİYON DÖRT KÖŞE TE
SEGMENTED CROSS TEE

PE100 - SDR 17 - PN10 ve SDR 11 - PN16

CROIX TÉ 90° SEGMENTÉ / КРЕСТОВИНА 90° (Сварной) / تي صليبية متساوية (ملففة)

SIRA	ÜRÜN KODU	ÇAP d [mm]	BASINÇ [bar]	L [mm]	L ₁ [mm]	e [mm]	AĞIRLIK [kg]	KOLİ ADEDİ	KOLİ EBATI
SEQ.	PRODUCT CODE	SIZE d [mm]	PRESSURE [bar]	L [mm]	L ₁ [mm]	e [mm]	WEIGHT [kg]	IN A PARCEL	PCS PRICE
1	97 6 009090	90*90	PN10	380,00	145,00	5,40	0,98	9	41/60/31
	97 7 009090		PN16			8,20	1,42		
2	97 6 110110	110*110	PN10	380,00	135,00	6,60	1,41	7	41/60/46
	97 7 110110		PN16			10,00	2,04		
3	97 6 125125	125*125	PN10	380,00	127,50	7,40	1,75	6	41/60/46
	97 7 125125		PN16			11,40	2,59		
4	97 6 140140	140*140	PN10	500,00	180,00	8,30	2,98	3	50/60/50
	97 7 140140		PN16			12,70	4,37		
5	97 6 160160	160*160	PN10	550,00	195,00	9,50	4,25	3	50/60/50
	97 7 160160		PN16			14,60	6,27		
6	97 6 180180	180*180	PN10	550,00	185,00	10,70	5,25	-	-
	97 7 180180		PN16			16,40	7,75		
7	97 6 200200	200*200	PN10	600,00	200,00	11,90	7,05	-	-
	97 7 200200		PN16			18,20	10,40		
8	97 6 225225	225*225	PN10	640,00	207,50	13,40	9,42	-	-
	97 7 225225		PN16			20,50	13,82		

water / gas

KONFEKSİYON DÖRT KÖŞE TE - SEGMENTED CROSS TEE - PE100 - SDR 17 - PN10 ve SDR 11 - PN16
CROIX TÉ 90° SEGMENTÉ / КРЕСТОВИНА 90° (Сварной) / تي صليبية متساوية (ملففة)

SIRA	ÜRÜN KODU	ÇAP d [mm]	BASINÇ [bar]	L [mm]	L ₁ [mm]	e [mm]	AĞIRLIK [kg]	KOLİ ADEDİ	KOLİ EBATI
SEQ	PRODUCT CODE	SIZE d [mm]	PRESSURE [bar]				WEIGHT [kg]	IN A PARCEL	PCS PRICE
9	97 6 250250	250*250	PN10	640,00	195,00	14,80	11,33	-	-
	97 7 250250		PN16			22,70	16,69		
10	97 6 280280	280*280	PN10	680,00	200,00	16,60	14,80	-	-
	97 7 280280		PN16			25,40	21,92		
11	97 6 315315	315*315	PN10	750,00	217,50	18,70	16,83	-	-
	97 7 315315		PN16			28,60	30,34		
12	97 6 355355	355*355	PN10	800,00	222,50	21,10	34,86	-	-
	97 7 355355		PN16			32,20	51,42		
13	97 6 400400	400*400	PN10	850,00	225,00	23,70	36,40	-	-
	97 7 400400		PN16			36,30	53,69		
14	97 6 450450	450*450	PN10	900,00	225,00	26,70	47,79	-	-
	97 7 450450		PN16			40,90	70,61		
15	97 6 500500	500*500	PN10	1000,00	250,00	29,70	65,70	-	-
	97 7 500500		PN16			45,40	96,75		
16	97 6 560560	560*560	PN10	1050,00	245,00	33,20	84,39	-	-
	97 7 560560		PN16			50,80	124,43		
17	97 6 630630	630*630	PN10	1100,00	235,00	37,40	108,96	-	-
	97 7 630630		PN16			57,20	160,14		

water / gas

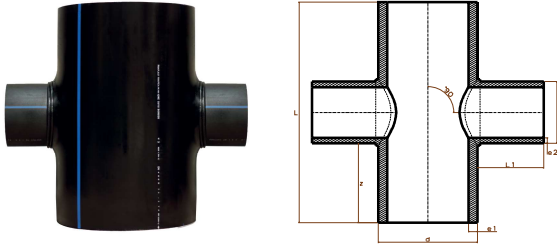

KONFEKSİYON DÖRT KÖŞE İNEGAL TE
SEGMENTED CROSS REDUCER TEE
PE100 - SDR 17 - PN10 ve SDR 11 - PN16

CROIX RÉDUIT TÉ 90° SEGMENTÉ / КРЕСТ ПЕРЕХОДНИК 90° (Сварной) / تي صليبية غير متساوية (ملففة)

SIRA	ÜRÜN KODU	ÇAP d [mm]	BASINÇ [bar]	L [mm]	L ₁ [mm]	z [mm]	e [mm]	e ₁ [mm]	AĞIRLIK [kg]	KOLİ ADEDİ	KOLİ EBATI
SEQ	PRODUCT CODE	SIZE d [mm]	PRESSURE [bar]						WEIGHT [kg]	IN A PARCEL	PCS PRICE
1	97 6 011063	110/63	PN10	340,00	100,00	138,50	6,60	3,80	0,88	10	41/60/46
	97 7 011063		PN16				10,00	5,80	1,28		
2	97 6 011075	110/75	PN10	340,00	100,00	132,50	6,60	4,50	0,94	10	41/60/46
	97 7 011075		PN16				10,00	6,80	1,36		
3	97 6 012563	125/63	PN10	340,00	100,00	138,50	7,40	3,80	1,08	8	41/60/46
	97 7 012563		PN16				11,40	5,80	1,60		
4	97 6 012575	125/75	PN10	340,00	100,00	132,50	7,40	4,50	1,14	8	41/60/46
	97 7 012575		PN16				11,40	6,80	1,68		
5	97 6 012590	125/90	PN10	450,00	130,00	193,50	7,40	5,40	1,62	7	41/60/46
	97 7 012590		PN16				11,40	8,20	2,39		
6	97 6 014063	140/63	PN10	340,00	100,00	132,50	8,30	3,80	1,32	7	41/60/46
	97 7 014063		PN16				12,70	5,80	1,94		

"Yıldız bize, Biz Su'ya yön gösteriyoruz..."
"The stars show us the way, we show way to the water..."

www.yildizpolietilen.com



KONFEKSİYON DÖRT KÖŞE İNEGAL TE - SEGMENTED CROSS REDUCER TEE
CROIX RÉDUIT TÉ 90° SEGMENTÉ / КРЕСТ ПЕРЕХОДНИК 90° (Сварной) / تي صليبية غير متساوية (ملفقة)
PE100 - SDR 17 - PN10 ve SDR 11 - PN16

SIRA	ÜRÜN KODU	ÇAP d [mm]	BASINÇ [bar]	L [mm]	L ₁ [mm]	z [mm]	e [mm]	e ₁ [mm]	AĞIRLIK [kg]	KOLİ ADEDİ	KOLİ EBATI
SEQ.	PRODUCT CODE	SIZE d [mm]	PRESSURE [bar]						WEIGHT [kg]	IN A PARCEL	PCS PRICE
7	97 6 014075	140/75	PN10	340,00	100,00	138,50	8,30	4,50	1,38	7	41/60/46
	97 7 014075		PN16						2,02		
8	97 6 014090	140/90	PN10	450,00	130,00	187,50	8,30	5,40	1,94	6	41/60/46
	97 7 014090		PN16						2,84		
9	97 6 140110	140/110	PN10	450,00	130,00	193,50	8,30	6,60	2,12	5	41/60/46
	97 7 140110		PN16						3,10		
10	97 6 016063	160/63	PN10	340,00	100,00	132,50	9,50	3,80	1,68	6	50/60/50
	97 7 016063		PN16						2,48		
11	97 6 016075	160/75	PN10	340,00	100,00	138,50	9,50	4,50	1,74	6	50/60/50
	97 7 016075		PN16						2,56		
12	97 8 016090	160/90	PN10	450,00	130,00	187,50	9,50	5,40	2,41	5	50/60/50
	97 9 016090		PN16						3,55		
13	97 6 160110	160/110	PN10	450,00	130,00	193,50	9,50	6,60	2,60	4	50/60/50
	97 7 160110		PN16						3,82		
14	97 8 160125	160/125	PN10	450,00	130,00	187,50	9,50	7,40	2,75	4	50/60/50
	97 9 160125		PN16						4,06		
15	97 6 018063	180/63	PN10	340,00	100,00	138,50	13,30	3,80	2,09	4	50/60/50
	97 7 018063		PN16						3,07		
16	97 6 018075	180/75	PN10	340,00	100,00	132,50	13,30	4,50	2,15	4	50/60/50
	97 7 018075		PN16						3,16		
17	97 6 018090	180/90	PN10	450,00	130,00	193,50	13,30	5,40	2,95	3	50/60/50
	97 7 018090		PN16						4,34		
18	97 6 180110	180/110	PN10	450,00	130,00	187,50	13,30	6,60	3,13	3	50/60/50
	97 7 180110		PN16						4,61		
19	97 6 180125	180/125	PN10	450,00	130,00	193,50	13,30	7,40	3,28	3	50/60/50
	97 7 180125		PN16						4,85		
20	97 6 180140	180/140	PN10	500,00	150,00	212,50	13,30	8,30	3,89	3	50/60/50
	97 7 180140		PN16						5,73		
21	97 6 020063	200/63	PN10	340,00	100,00	138,50	11,90	3,80	2,54	3	50/60/50
	97 7 020063		PN16						3,75		
22	97 6 020075	200/75	PN10	340,00	100,00	132,50	11,90	4,50	2,60	3	50/60/50
	97 7 020075		PN16						3,83		
23	97 6 020090	200/90	PN10	450,00	130,00	193,50	11,90	5,40	3,55	3	50/60/50
	97 7 020090		PN16						5,23		
24	97 6 200110	200/110	PN10	450,00	130,00	187,50	11,90	6,60	3,74	2	50/60/50
	97 7 200110		PN16						5,50		
25	97 6 200125	200/125	PN10	450,00	130,00	193,50	11,90	7,40	3,89	2	50/60/50
	97 7 200125		PN16						5,74		

water / gas

KONFEKSİYON DÖRT KÖŞE İNEGAL TE - SEGMENTED CROSS REDUCER TEE
 CROIX RÉDUIT Té 90° SEGMENTÉ / КРЕСТ ПЕРЕХОДНИК 90° (Сварной) / تيصلية غير متساوية (ملففة)
 PE100 - SDR 17 - PN10 ve SDR 11 - PN16

water / gas

SIRA	ÜRÜN KODU	ÇAP d [mm]	BASINÇ [bar]	L [mm]	L ₁ [mm]	z [mm]	e [mm]	e ₁ [mm]	AĞIRLIK [kg]	KOLİ ADEDİ	KOLİ EBATI
SEQ	PRODUCT CODE	SIZE d [mm]	PRESSURE [bar]						WEIGHT [kg]	IN A PARCEL	PCS PRICE
26	97 6 200140	200/140	PN10	500,00	150,00	212,50	11,90	8,30	4,56	-	-
	PN16		6,72								
27	97 6 200160	200/160	PN10	550,00	150,00	243,50	11,90	9,50	5,23	-	-
	PN16		7,72								
28	97 6 022563	225/63	PN10	340,00	100,00	132,50	13,40	3,80	3,18	-	-
	PN16		4,66								
29	97 6 022575	225/75	PN10	340,00	100,00	138,50	13,40	4,50	3,24	-	-
	PN16		4,75								
30	97 6 022590	225/90	PN10	450,00	130,00	187,50	13,40	5,40	4,40	-	-
	PN16		6,45								
31	97 6 225110	225/110	PN10	450,00	130,00	193,50	13,40	6,60	4,58	-	-
	PN16		6,71								
32	97 6 225140	225/140	PN10	500,00	150,00	212,50	13,40	8,30	5,50	-	-
	PN16		8,07								
33	97 6 225160	225/160	PN10	550,00	150,00	243,50	13,40	9,50	6,27	-	-
	PN16		9,21								
34	97 6 225180	225/180	PN10	550,00	150,00	237,50	13,40	10,70	6,62	-	-
	PN16		9,73								
35	97 6 025063	250/63	PN10	340,00	100,00	138,50	14,80	3,80	3,88	-	-
	PN16		5,72								
36	97 6 025075	250/75	PN10	340,00	100,00	132,50	14,80	4,50	3,94	-	-
	PN16		5,80								
37	97 6 025090	250/90	PN10	450,00	130,00	193,50	14,80	5,40	5,33	-	-
	PN16		7,84								
38	97 6 250110	250/110	PN10	450,00	130,00	187,50	14,80	6,60	5,51	-	-
	PN16		8,11								
39	97 6 250125	250/125	PN10	450,00	130,00	193,50	14,80	7,40	5,67	-	-
	PN16		8,35								
40	97 6 250140	250/140	PN10	500,00	150,00	212,50	14,80	8,30	6,54	-	-
	PN16		9,62								
41	97 6 250160	250/160	PN10	550,00	150,00	243,50	14,80	9,50	7,41	-	-
	PN16		10,91								
42	97 6 250180	250/180	PN10	550,00	150,00	237,50	14,80	10,70	7,76	-	-
	PN16		11,44								
43	97 6 250200	250/200	PN10	600,00	170,00	268,50	14,80	11,90	9,00	-	-
	PN16		13,26								
44	97 6 028063	280/63	PN10	340,00	100,00	132,50	16,60	3,80	4,80	-	-
	PN16		7,11								

"Yıldız bize, Biz Su'ya yön gösteriyoruz..."
 "The stars show us the way, we show way to the water..."

www.yildizpolietilen.com



KONFEKSİYON DÖRT KÖŞE İNEGAL TE - SEGMENTED CROSS REDUCER TEE
 CROIX RÉDUIT TÉ 90° SEGMENTÉ / КРЕСТ ПЕРЕХОДНИК 90° (Сварной) / تيصلية غير متساوية (ملفقة)
 PE100 - SDR 17 - PN10 ve SDR 11 - PN16

SIRA	ÜRÜN KODU	ÇAP d [mm]	BASINÇ [bar]	L [mm]	L ₁ [mm]	z [mm]	e [mm]	e ₁ [mm]	AĞIRLIK [kg]	KOLİ ADEDİ	KOLİ EBATI
SEQ	PRODUCT CODE	SIZE d [mm]	PRESSURE [bar]						WEIGHT [kg]	IN A PARCEL	PCS PRICE
45	97 6 028075	280/75	PN10	340,00	100,00	138,50	16,60	4,50	4,86	-	-
	97 7 028075		PN16						7,20		
46	97 6 028090	280/90	PN10	450,00	130,00	187,50	16,60	5,40	6,54	-	-
	97 7 028090		PN16						9,69		
47	97 6 280110	280/110	PN10	450,00	130,00	193,50	16,60	6,60	6,73	-	-
	97 7 280110		PN16						9,95		
48	97 6 280125	280/125	PN10	450,00	130,00	187,50	16,60	7,40	6,88	-	-
	97 7 280125		PN16						10,20		
49	97 6 280140	280/140	PN10	500,00	150,00	218,50	16,60	8,30	7,89	-	-
	97 7 280140		PN16						11,67		
50	97 6 280160	280/160	PN10	550,00	150,00	237,50	16,60	9,50	8,89	-	-
	97 7 280160		PN16						13,17		
51	97 6 280200	280/200	PN10	600,00	170,00	268,50	16,60	10,70	10,62	-	-
	97 7 280200		PN16						15,72		
52	97 6 280225	280/225	PN10	650,00	170,00	287,50	16,60	11,90	11,30	-	-
	97 7 280225		PN16						16,73		
53	97 6 031563	315/63	PN10	340,00	100,00	138,50	18,70	3,80	6,61	-	-
	97 7 031563		PN16						11,32		
54	97 6 031575	315/75	PN10	340,00	100,00	132,50	18,70	5,40	5,03	-	-
	97 7 031575		PN16						9,00		
55	97 6 031590	315/90	PN10	450,00	130,00	193,50	18,70	6,60	6,77	-	-
	97 7 031590		PN16						12,07		
56	97 6 315110	315/110	PN10	450,00	130,00	187,50	18,70	7,40	6,95	-	-
	97 7 315110		PN16						12,34		
57	97 6 315125	315/125	PN10	450,00	130,00	193,50	18,70	8,30	7,11	-	-
	97 7 315125		PN16						12,58		
58	97 6 315140	315/140	PN10	500,00	150,00	212,50	18,70	9,50	8,14	-	-
	97 7 315140		PN16						14,32		
59	97 6 315160	315/160	PN10	550,00	150,00	243,50	18,70	10,70	9,17	-	-
	97 7 315160		PN16						16,08		
60	97 6 315180	315/180	PN10	550,00	150,00	237,50	18,70	11,90	9,52	-	-
	97 7 315180		PN16						16,61		
61	97 6 315200	315/200	PN10	600,00	170,00	268,50	18,70	13,40	10,92	-	-
	97 7 315200		PN16						18,90		
62	97 6 315225	315/225	PN10	650,00	170,00	287,50	18,70	14,80	12,27	-	-
	97 7 315225		PN16						21,09		
63	97 6 315250	315/250	PN10	650,00	170,00	293,50	18,70	14,80	12,97	-	-
	97 7 315250		PN16						22,15		

water / gas

KONFEKSİYON DÖRT KÖŞE İNEGAL TE - SEGMENTED CROSS REDUCER TEE
 CROIX RÉDUIT TÉ 90° SEGMENTÉ / КРЕСТ ПЕРЕХОДНИК 90° (Сварной) / تيصلية غير متساوية (ملفحة)
 PE100 - SDR 17 - PN10 ve SDR 11 - PN16

water / gas

SIRA	ÜRÜN KODU	ÇAP d [mm]	BASINÇ [bar]	L [mm]	L ₁ [mm]	z [mm]	e [mm]	e ₁ [mm]	AĞIRLIK [kg]	KOLİ ADEDİ	KOLİ EBATI
SEQ	PRODUCT CODE	SIZE d [mm]	PRESSURE [bar]						WEIGHT [kg]	IN A PARCEL	PCS PRICE
64	97 6 040063	400/63	PN10	340,00	100,00	132,50	23,70	3,80	9,66	-	-
	97 7 040063		PN16						14,25		
65	97 6 040075	400/75	PN10	340,00	100,00	138,50	23,70	4,50	9,72	-	-
	97 7 040075		PN16						14,34		
66	97 6 040090	400/90	PN10	450,00	130,00	187,50	23,70	5,40	12,98	-	-
	97 7 040090		PN16						19,14		
67	97 6 400110	400/110	PN10	450,00	130,00	193,50	23,70	6,60	13,16	-	-
	97 7 400110		PN16						19,40		
68	97 6 400125	400/125	PN10	450,00	130,00	187,50	23,70	7,40	13,32	-	-
	97 7 400125		PN16						19,65		
69	97 6 400140	400/140	PN10	500,00	150,00	218,50	23,70	8,30	15,04	-	-
	97 7 400140		PN16						22,17		
70	97 6 400160	400/160	PN10	550,00	150,00	237,50	23,70	9,50	16,76	-	-
	97 7 400160		PN16						24,72		
71	97 6 400180	400/180	PN10	550,00	150,00	243,50	23,70	10,70	17,11	-	-
	97 7 400180		PN16						25,24		
72	97 6 400200	400/200	PN10	600,00	170,00	262,50	23,70	11,90	19,20	-	-
	97 7 400200		PN16						28,32		
73	97 6 400225	400/225	PN10	650,00	170,00	293,50	23,70	13,40	21,24	-	-
	97 7 400225		PN16						31,30		
74	97 6 400250	400/250	PN10	650,00	170,00	287,50	23,70	14,80	21,94	-	-
	97 7 400250		PN16						32,35		
75	97 6 400280	400/280	PN10	700,00	170,00	318,50	23,70	16,60	24,26	-	-
	97 7 400280		PN16						35,81		
76	97 6 400315	400/315	PN10	750,00	170,00	337,50	23,70	18,70	26,92	-	-
	97 7 400315		PN16						39,68		
77	97 6 045063	450/63	PN10	340,00	100,00	138,50	26,70	3,80	12,18	-	-
	97 7 045063		PN16						17,99		
78	97 6 045075	450/75	PN10	340,00	100,00	132,50	26,70	4,50	12,24	-	-
	97 7 045075		PN16						18,08		
79	97 6 045090	450/90	PN10	450,00	130,00	193,50	26,70	5,40	16,31	-	-
	97 7 045090		PN16						24,09		
80	97 6 450110	450/110	PN10	450,00	130,00	187,50	26,70	6,60	16,49	-	-
	97 7 450110		PN16						24,35		
81	97 6 450125	450/125	PN10	450,00	130,00	193,50	26,70	7,40	16,65	-	-
	97 7 450125		PN16						24,60		
82	97 6 450140	450/140	PN10	500,00	150,00	212,50	26,70	8,30	18,74	-	-
	97 7 450140		PN16						27,67		

"Yıldız bize, Biz Su'ya yön gösteriyoruz..."
 "The stars show us the way, we show way to the water..."

www.yildizpolietilen.com



KONFEKSİYON DÖRT KÖŞE İNEGAL TE - SEGMENTED CROSS REDUCER TEE
 CROIX RÉDUIT TÉ 90° SEGMENTÉ / КРЕСТ ПЕРЕХОДНИК 90° (Сварной) / تىصلية غير متساوية (ملفقة)
 PE100 - SDR 17 - PN10 ve SDR 11 - PN16

SIRA	ÜRÜN KODU	ÇAP d [mm]	BASINÇ [bar]	L [mm]	L ₁ [mm]	z [mm]	e [mm]	e ₁ [mm]	AĞIRLIK [kg]	KOLİ ADEDİ	KOLİ EBATI
SEQ	PRODUCT CODE	SIZE d [mm]	PRESSURE [bar]						WEIGHT [kg]	IN A PARCEL	PCS PRICE
83	97 6 450160	450/160	PN10	550,00	150,00	243,50	26,70	9,50	20,83	-	-
	PN16		40,90						14,60		
84	97 6 450180	450/180	PN10	550,00	150,00	237,50	26,70	10,70	21,18	-	-
	PN16		40,90						16,40		
85	97 6 450200	450/200	PN10	600,00	170,00	268,50	26,70	11,90	23,64	-	-
	PN16		40,90						18,20		
86	97 6 450225	450/225	PN10	650,00	170,00	287,50	26,70	13,40	26,05	-	-
	PN16		40,90						20,50		
87	97 6 450250	450/250	PN10	650,00	170,00	293,50	26,70	14,80	26,75	-	-
	PN16		40,90						22,70		
88	97 6 450280	450/280	PN10	700,00	170,00	312,50	26,70	16,60	29,44	-	-
	PN16		40,90						25,40		
89	97 6 450315	450/315	PN10	750,00	170,00	343,50	26,70	18,70	32,47	-	-
	PN16		40,90						28,60		
90	97 6 450355	450/355	PN10	800,00	170,00	362,50	26,70	21,10	35,83	-	-
	PN16		40,90						32,20		
91	97 6 050063	500/63	PN10	400,00	100,00	168,50	26,70	3,80	17,66	-	-
	PN16		40,90						5,80		
92	97 6 050075	500/75	PN10	400,00	100,00	162,50	26,70	4,50	17,72	-	-
	PN16		40,90						6,80		
93	97 6 050090	500/90	PN10	450,00	130,00	193,50	29,70	5,40	20,09	-	-
	PN16		45,40						8,20		
94	97 6 500110	500/110	PN10	450,00	130,00	187,50	29,70	6,60	20,27	-	-
	PN16		45,40						10,00		
95	97 6 500125	500/125	PN10	450,00	130,00	193,50	29,70	7,40	20,43	-	-
	PN16		45,40						11,40		
96	97 6 500140	500/140	PN10	500,00	150,00	212,50	29,70	8,30	22,94	-	-
	PN16		45,40						12,70		
97	97 6 500160	500/160	PN10	550,00	150,00	243,50	29,70	9,50	25,45	-	-
	PN16		45,40						14,60		
98	97 6 500180	500/180	PN10	550,00	150,00	237,50	29,70	10,70	25,80	-	-
	PN16		45,40						16,40		
99	97 6 500200	500/200	PN10	600,00	170,00	268,50	29,70	11,90	28,68	-	-
	PN16		45,40						18,20		
100	97 6 500225	500/225	PN10	650,00	170,00	287,50	29,70	13,40	31,51	-	-
	PN16		45,40						20,50		
101	97 6 500250	500/250	PN10	650,00	170,00	293,50	29,70	14,80	32,21	-	-
	PN16		45,40						22,70		

water / gas

KONFEKSİYON DÖRT KÖŞE İNEGAL TE - SEGMENTED CROSS REDUCER TEE
CROIX RÉDUIT TÉ 90° SEGMENTÉ / КРЕСТ ПЕРЕХОДНИК 90° (Сварной) / توصيلة غير متساوية (ملفقة)
PE100 - SDR 17 - PN10 ve SDR 11 - PN16

SIRA	ÜRÜN KODU	ÇAP d [mm]	BASINÇ [bar]	L [mm]	L ₁ [mm]	z [mm]	e [mm]	e ₁ [mm]	AĞIRLIK [kg]	KOLİ ADEDİ	KOLİ EBATI
SEQ	PRODUCT CODE	SIZE d [mm]	PRESSURE [bar]						WEIGHT [kg]	IN A PARCEL	PCS PRICE
102	97 6 500280	500/280	PN10	700,00	170,00	312,50	29,70	16,60	35,32	-	-
	97 7 500280		PN16						52,05		
103	97 6 500315	500/315	PN10	750,00	170,00	343,50	29,70	18,70	38,77	-	-
	97 7 500315		PN16						57,08		
104	97 6 500355	500/355	PN10	800,00	170,00	362,50	29,70	21,10	42,55	-	-
	97 7 500355		PN16						62,65		
105	97 6 500400	500/400	PN10	850,00	200,00	393,50	29,70	23,70	48,43	-	-
	97 7 500400		PN16						71,35		

water / gas

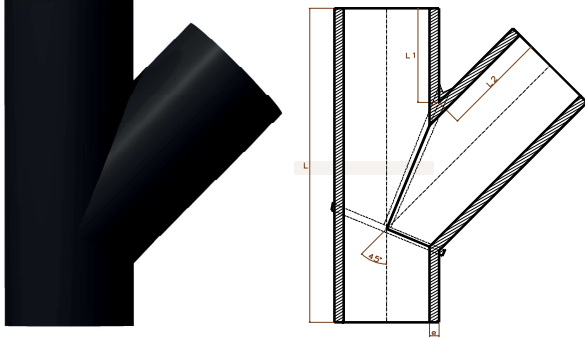

KONFEKSİYON Y TİPİ ÇATAL TE
SEGMENTED BRANCH TEE
PE100 - SDR 17 - PN10 ve SDR 11 - PN16

TÉ 45° SEGMENTÉ / РАВНОПРОХОДНОЙ КОСОЙТРОЙНИК 45° (Сварной) / فرع 45° درجة متساوية (ملفقة)

SIRA	ÜRÜN KODU	ÇAP d [mm]	BASINÇ [bar]	L [mm]	L ₁ [mm]	L ₂ [mm]	e [mm]	AĞIRLIK [kg]	KOLİ ADEDİ	KOLİ EBATI
SEQ	PRODUCT CODE	SIZE d [mm]	PRESSURE [bar]					WEIGHT [kg]	IN A PARCEL	PCS PRICE
1	97 8 009090	90*90	PN10	450,00	140,00	150,00	5,40	0,92	10	41/60/46
	97 9 009090		PN16					1,34		
2	97 8 110110	110*110	PN10	450,00	140,00	150,00	6,60	1,39	7	41/60/46
	97 9 110110		PN16					2,01		
3	97 8 125125	125*125	PN10	480,00	140,00	150,00	7,40	1,85	6	41/60/46
	97 9 125125		PN16					2,75		
4	97 8 140140	140*140	PN10	550,00	160,00	180,00	8,30	2,70	5	50/60/50
	97 9 140140		PN16					3,96		
5	97 8 160160	160*160	PN10	550,00	160,00	180,00	9,50	3,56	4	50/60/50
	97 9 160160		PN16					5,25		
6	97 8 180180	180*180	PN10	600,00	180,00	200,00	10,70	4,93	3	50/60/50
	97 9 180180		PN16					7,27		
7	97 8 200200	200*200	PN10	600,00	180,00	200,00	11,90	6,14	2	41/60/46
	97 9 200200		PN16					9,06		
8	97 8 225225	225*225	PN10	700,00	180,00	200,00	13,40	8,75	2	50/60/50
	97 9 225225		PN16					12,83		
9	97 8 250250	250*250	PN10	700,00	180,00	200,00	14,80	10,87	-	-
	97 9 250250		PN16					16,01		
10	97 8 280280	280*280	PN10	750,00	180,00	200,00	16,60	14,37	-	-
	97 9 280280		PN16					21,29		

"Yıldız bize, Biz Su'ya yön gösteriyoruz..."
"The stars show us the way, we show way to the water..."

www.yildizpolietilen.com



KONFEKSİYON Y TİPİ ÇATAL TE - SEGMENTED BRANCH TEE - PE100 - SDR 17 - PN10 ve SDR 11 - PN16
TÉ 45° SEGMENTÉ / РАВНОПРОХОДНОЙ КОСОЙТРОЙНИК 45° (Сварной) / فرع 45° درجة متساوية (ملفقة)

SIRA	ÜRÜN KODU	ÇAP d [mm]	BASINÇ [bar]	L [mm]	L ₁ [mm]	L ₂ [mm]	e [mm]	AĞIRLIK [kg]	KOLİ ADEDİ	KOLİ EBATI
SEQ	PRODUCT CODE	SIZE d [mm]	PRESSURE [bar]					WEIGHT [kg]	IN A PARCEL	PCS PRICE
11	97 8 315315	315*315	PN10	820,00	180,00	200,00	18,70	19,69	-	-
	97 9 315315		PN16					28,60		
12	97 8 355355	355*355	PN10	920,00	200,00	220,00	21,10	27,97	-	-
	97 9 355355		PN16					32,20		
13	97 8 400400	400*400	PN10	1050,00	200,00	220,00	23,70	39,52	-	-
	97 9 400400		PN16					36,30		
14	97 8 450450	450*450	PN10	1150,00	200,00	220,00	26,70	54,13	-	-
	97 9 450450		PN16					40,90		
15	97 8 500500	500*500	PN10	1300,00	200,00	220,00	29,70	74,32	-	-
	97 9 500500		PN16					45,40		
16	97 8 560560	560*560	PN10	1400,00	200,00	220,00	33,20	99,63	-	-
	97 9 560560		PN16					50,80		
17	97 8 630630	630*630	PN10	1500,00	200,00	220,00	37,40	134,83	-	-
	97 9 630630		PN16					57,20		

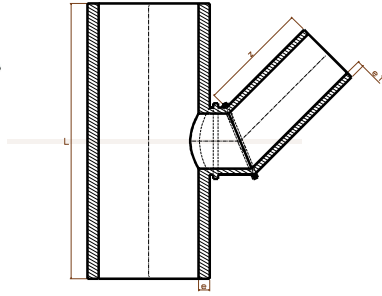

water / gas

KONFEKSİYON İNEGAL ÇATAL
SEGMENTED SPECIAL DEGREE REDUCED TEE
PE100 - SDR 17 - PN10 ve SDR 11 - PN16

TÉ 45° RÉDUIT SEGMENTÉ / НЕ РАВНОПРОХОДНОЙ КОСОЙТРОЙНИК 45° (Сварной) / فرع 45° درجة غير متساوية (ملفقة)

SIRA	ÜRÜN KODU	ÇAP d [mm]	BASINÇ [bar]	L [mm]	L ₁ [mm]	z [mm]	e [mm]	AĞIRLIK [kg]	KOLİ ADEDİ	KOLİ EBATI
SEQ	PRODUCT CODE	SIZE d [mm]	PRESSURE [bar]					WEIGHT [kg]	IN A PARCEL	PCS PRICE
1	97 8 011090	110/90	PN10	450,00	180,00	6,60	5,40	1,38	10	41/60/46
	97 9 011090		PN16					8,20		
2	97 8 012563	125/63	PN10	340,00	140,00	7,40	3,80	1,09	10	41/60/46
	97 9 012563		PN16					5,80		
3	97 8 012575	125/75	PN10	340,00	140,00	7,40	4,50	1,17	10	41/60/46
	97 9 012575		PN16					6,80		
4	97 8 012590	125/90	PN10	450,00	180,00	7,40	5,40	1,64	8	41/60/46
	97 9 012590		PN16					8,20		
5	97 8 125110	125/110	PN10	450,00	180,00	7,40	6,60	1,86	8	41/60/46
	97 9 125110		PN16					10,00		
6	97 8 014050	140/50	PN10	340,00	140,00	8,30	3,00	1,27	7	41/60/46
	97 9 014050		PN16					4,60		
7	97 8 014063	140/63	PN10	340,00	140,00	8,30	3,80	1,34	7	41/60/46
	97 9 014063		PN16					5,80		
8	97 8 014075	140/75	PN10	340,00	140,00	8,30	4,50	1,41	6	41/60/46
	97 9 014075		PN16					6,80		

KONFEKSİYON İNEGAL ÇATAL - SEGMENTED SPECIAL DEGREE REDUCED TEE
 TÉ 45° RÉDUIT SEGMENTÉ / НЕ РАВНОПРОХОДНОЙ КОСОЙТРОЙНИК 45° (Сварной) / فرع 45° درجة غير متساوية (ملفقة)
 PE100 - SDR 17 - PN10 ve SDR 11 - PN16

SIRA	ÜRÜN KODU	ÇAP d [mm]	BASINÇ [bar]	L [mm]	L ₁ [mm]	z [mm]	e [mm]	AĞIRLIK [kg]	KOLİ ADEDİ	KOLİ EBATI
SEQ	PRODUCT CODE	SIZE d [mm]	PRESSURE [bar]					WEIGHT [kg]	IN A PARCEL	PCS PRICE
9	97 8 014090	140/90	PN10	450,00	180,00	8,30	5,40	1,96	6	41/60/46
	97 9 014090		PN16				8,20	2,87		
10	97 8 140110	140/110	PN10	450,00	180,00	8,30	6,60	2,18	5	41/60/46
	97 9 140110		PN16				10,00	3,18		
11	97 8 140125	140/125	PN10	450,00	140,00	8,30	7,40	2,25	5	41/60/46
	97 9 140125		PN16				11,40	3,32		
12	97 8 016063	160/63	PN10	340,00	140,00	9,50	3,80	1,70	7	50/60/50
	97 9 016063		PN16				5,80	2,50		
13	97 8 016075	160/75	PN10	340,00	140,00	9,50	4,50	1,77	7	50/60/50
	97 9 016075		PN16				6,80	2,60		
14	97 8 016090	160/90	PN10	450,00	180,00	9,50	5,40	2,44	6	50/60/50
	97 9 016090		PN16				8,20	3,58		
15	97 8 160110	160/110	PN10	450,00	180,00	9,50	6,60	2,65	6	50/60/50
	97 9 160110		PN16				10,00	3,90		
16	97 8 160125	160/125	PN10	450,00	180,00	9,50	7,40	2,84	6	50/60/50
	97 9 160125		PN16				11,40	4,19		
17	97 8 160140	160/140	PN10	500,00	200,00	9,50	8,30	3,37	5	50/60/50
	97 9 160140		PN16				12,70	4,96		
18	97 8 018090	180/90	PN10	450,00	180,00	10,70	5,40	2,97	4	50/60/50
	97 9 018090		PN16				8,20	4,37		
19	97 8 180110	180/110	PN10	450,00	180,00	10,70	6,60	3,19	4	50/60/50
	97 9 180110		PN16				10,00	4,68		
20	97 8 180125	180/125	PN10	450,00	180,00	10,70	7,40	3,37	4	50/60/50
	97 9 180125		PN16				11,40	4,98		
21	97 8 180140	180/140	PN10	500,00	200,00	10,70	8,30	3,96	4	50/60/50
	97 9 180140		PN16				12,70	5,84		
22	97 8 180160	180/160	PN10	550,00	200,00	10,70	9,50	4,63	4	50/60/50
	97 9 180160		PN16				14,60	6,83		
23	97 8 020050	200/50	PN10	340,00	140,00	11,90	3,00	2,49	4	50/60/50
	97 9 020050		PN16				0,67	3,68		
24	97 8 020063	200/63	PN10	340,00	140,00	11,90	3,80	2,56	4	50/60/50
	97 9 020063		PN16				5,80	3,77		
25	97 8 020075	200/75	PN10	340,00	140,00	11,90	4,50	2,63	4	50/60/50
	97 9 020075		PN16				6,80	3,87		
26	97 8 020090	200/90	PN10	450,00	180,00	11,90	5,40	3,57	3	50/60/50
	97 9 020090		PN16				8,20	5,26		
27	97 8 200110	200/110	PN10	450,00	180,00	11,90	6,60	3,79	3	50/60/50
	97 9 200110		PN16				10,00	5,57		
28	97 8 200125	200/125	PN10	450,00	180,00	11,90	7,40	3,98	3	50/60/50
	97 9 200125		PN16				11,40	5,87		

water / gas

"Yıldız bize, Biz Su'ya yön gösteriyoruz..."
 "The stars show us the way, we show way to the water..."

www.yildizpolietilen.com



KONFEKSİYON İNEGAL ÇATAL - SEGMENTED SPECIAL DEGREE REDUCED TEE

TÉ 45° RÉDUIT SEGMENTÉ / НЕ РАВНОПРОХОДНОЙ КОСОЙТРОЙНИК 45° (Сварной) / فرع 45° درجة غير متساوية (ملففة)
 PE100 - SDR 17 - PN10 ve SDR 11 - PN16

SIRA	ÜRÜN KODU	ÇAP d [mm]	BASINÇ [bar]	L [mm]	L ₁ [mm]	z [mm]	e [mm]	AĞIRLIK [kg]	KOLİ ADEDİ	KOLİ EBATI
SEQ	PRODUCT CODE	SIZE d [mm]	PRESSURE [bar]					WEIGHT [kg]	IN A PARCEL	PCS PRICE
29	97 8 200140	200/140	PN10	500,00	200,00	11,90	8,30	4,63	3	50/60/50
	97 9 200140		PN16				12,70	6,83		
30	97 8 200160	200/160	PN10	550,00	200,00	11,90	9,50	5,37	3	50/60/50
	97 9 200160		PN16				14,60	7,92		
31	97 8 200180	200/180	PN10	550,00	200,00	11,90	10,70	5,82	2	50/60/50
	97 9 200180		PN16				16,40	8,58		
32	97 8 022563	225/63	PN10	340,00	140,00	13,40	3,80	3,20	-	-
	97 9 022563		PN16				5,80	4,69		
33	97 8 022575	225/75	PN10	340,00	140,00	13,40	4,50	3,27	-	-
	97 9 022575		PN16				6,80	4,79		
34	97 8 022590	225/90	PN10	450,00	180,00	13,40	5,40	4,42	-	-
	97 9 022590		PN16				8,20	6,48		
35	97 8 225110	225/110	PN10	450,00	180,00	13,40	6,60	4,64	-	-
	97 9 225110		PN16				10,00	6,79		
36	97 8 225125	225/125	PN10	550,00	180,00	13,40	7,40	5,72	-	-
	97 9 225125		PN16				11,40	8,40		
37	97 8 225140	225/140	PN10	500,00	200,00	13,40	8,30	5,57	-	-
	97 9 225140		PN16				12,70	8,18		
38	97 8 225160	225/160	PN10	550,00	200,00	13,40	9,50	6,40	-	-
	97 9 225160		PN16				14,60	9,41		
39	97 8 225180	225/180	PN10	550,00	200,00	13,40	10,70	6,85	-	-
	97 9 225180		PN16				16,40	10,07		
40	97 8 225200	225/200	PN10	600,00	220,00	13,40	11,90	7,97	-	-
	97 9 225200		PN16				18,20	11,71		
41	97 8 025063	250/63	PN10	340,00	140,00	14,80	3,80	3,90	-	-
	97 9 025063		PN16				5,80	5,74		
42	97 8 025075	250/75	PN10	340,00	140,00	14,80	4,50	3,97	-	-
	97 9 025075		PN16				6,80	5,84		
43	97 8 025090	250/90	PN10	450,00	180,00	14,80	5,40	5,35	-	-
	97 9 025090		PN16				8,20	7,87		
44	97 8 250110	250/110	PN10	480,00	180,00	14,80	6,60	5,90	-	-
	97 9 250110		PN16				10,00	8,67		
45	97 8 250125	250/125	PN10	450,00	180,00	14,80	7,40	5,75	-	-
	97 9 250125		PN16				11,40	8,48		
46	97 8 250140	250/140	PN10	500,00	200,00	14,80	8,30	6,61	-	-
	97 9 250140		PN16				12,70	9,73		
47	97 8 250160	250/160	PN10	550,00	200,00	14,80	9,50	7,54	-	-
	97 9 250160		PN16				14,60	11,11		
48	97 8 250180	250/180	PN10	550,00	200,00	14,80	10,70	7,99	-	-
	97 9 250180		PN16				16,40	11,77		

water / gas

KONFEKSİYON İNEĞAL ÇATAL - SEGMENTED SPECIAL DEGREE REDUCED TEE
 TÉ 45° RÉDUIT SEGMENTÉ / НЕ РАВНОПРОХОДНОЙ КОСОЙТРОЙНИК 45° (Сварной) / فرع 45° درجة غير متساوية (ملففة)
 PE100 - SDR 17 - PN10 ve SDR 11 - PN16

SIRA	ÜRÜN KODU	ÇAP d [mm]	BASINÇ [bar]	L [mm]	L ₁ [mm]	z [mm]	e [mm]	AĞIRLIK [kg]	KOLİ ADEDİ	KOLİ EBATI
SEQ.	PRODUCT CODE	SIZE d [mm]	PRESSURE [bar]					WEIGHT [kg]	IN A PARCEL	PCS PRICE
49	97 8 250200	250/200	PN10	600,00	220,00	14,80	11,90	9,21	-	-
	97 9 250200		PN16				18,20	13,57		
50	97 8 250225	250/225	PN10	650,00	220,00	14,80	13,40	10,57	-	-
	97 9 250225		PN16				20,50	15,54		
51	97 8 028063	280/63	PN10	340,00	140,00	16,60	3,80	4,82	-	-
	97 9 028063		PN16				5,80	7,13		
52	97 8 028075	280/75	PN10	340,00	140,00	16,60	4,50	4,89	-	-
	97 9 028075		PN16				6,80	7,24		
53	97 8 028090	280/90	PN10	450,00	180,00	16,60	5,40	6,57	-	-
	97 9 028090		PN16				8,20	9,72		
54	97 8 280110	280/110	PN10	450,00	180,00	16,60	6,60	6,78	-	-
	97 9 280110		PN16				10,00	10,03		
55	97 8 280125	280/125	PN10	450,00	180,00	16,60	7,40	6,97	-	-
	97 9 280125		PN16				11,40	10,33		
56	97 8 280140	280/140	PN10	500,00	200,00	16,60	8,30	7,96	-	-
	97 9 280140		PN16				12,70	11,78		
57	97 8 280160	280/160	PN10	550,00	200,00	16,60	9,50	9,03	-	-
	97 9 280160		PN16				14,60	13,37		
58	97 8 280180	280/180	PN10	550,00	200,00	16,60	10,70	9,48	-	-
	97 9 280180		PN16				16,40	14,03		
59	97 8 280200	280/200	PN10	600,00	220,00	16,60	11,90	10,83	-	-
	97 9 280200		PN16				18,20	16,03		
60	97 8 280225	280/225	PN10	650,00	220,00	16,60	13,40	12,32	-	-
	97 9 280225		PN16				20,50	18,21		
61	97 8 280250	280/250	PN10	650,00	220,00	16,60	14,80	13,25	-	-
	97 9 280250		PN16				22,70	19,59		
62	97 8 031563	315/63	PN10	340,00	140,00	18,70	3,80	6,08	-	-
	97 9 031563		PN16				5,80	8,94		
63	97 8 031575	315/75	PN10	340,00	140,00	18,70	4,50	6,15	-	-
	97 9 031575		PN16				6,80	9,04		
64	97 8 031590	315/90	PN10	450,00	180,00	18,70	5,40	8,23	-	-
	97 9 031590		PN16				8,20	12,10		
65	97 8 315110	315/110	PN10	450,00	180,00	18,70	6,60	8,45	-	-
	97 9 315110		PN16				10,00	12,41		
66	97 8 315125	315/125	PN10	450,00	180,00	18,70	7,40	8,63	-	-
	97 9 315125		PN16				11,40	12,71		
67	97 8 315140	315/140	PN10	500,00	200,00	18,70	8,30	9,81	-	-
	97 9 315140		PN16				12,70	14,43		
68	97 8 315160	315/160	PN10	550,00	200,00	18,70	9,50	11,06	-	-
	97 9 315160		PN16				14,60	16,28		

water / gas

"Yıldız bize, Biz Su'ya yön gösteriyoruz..."
 "The stars show us the way, we show way to the water..."

www.yildizpolietilen.com



KONFEKSİYON İNEGAL ÇATAL - SEGMENTED SPECIAL DEGREE REDUCED TEE
 TÉ 45° RÉDUIT SEGMENTÉ / НЕ РАВНОПРОХОДНОЙ КОСОЙТРОЙНИК 45° (Сварной) / فرع 45° درجة غير متساوية (ملفقة)
 PE100 - SDR 17 - PN10 ve SDR 11 - PN16

SIRA	ÜRÜN KODU	ÇAP d [mm]	BASINÇ [bar]	L [mm]	L ₁ [mm]	z [mm]	e [mm]	AĞIRLIK [kg]	KOLİ ADEDİ	KOLİ EBATI
SEQ	PRODUCT CODE	SIZE d [mm]	PRESSURE [bar]					WEIGHT [kg]	IN A PARCEL	PCS PRICE
69	97 8 315180	315/180	PN10	550,00	200,00	18,70	10,70	11,51	-	-
	97 9 315180		PN16				16,40	16,94		
70	97 8 315200	315/200	PN10	600,00	220,00	18,70	11,90	13,05	-	-
	97 9 315200		PN16				18,20	19,21		
71	97 8 315225	315/225	PN10	650,00	220,00	18,70	13,40	14,73	-	-
	97 9 315225		PN16				20,50	21,65		
72	97 8 315250	315/250	PN10	650,00	220,00	18,70	14,80	15,66	-	-
	97 9 315250		PN16				22,70	23,04		
73	97 8 315280	315/280	PN10	700,00	240,00	18,70	16,60	18,07	-	-
	97 9 315280		PN16				25,40	26,65		
74	97 8 035563	355/63	PN10	360,00	140,00	21,10	3,80	7,76	-	-
	97 9 035563		PN16				5,80	11,93		
75	97 8 035575	355/75	PN10	360,00	140,00	21,10	4,50	7,83	-	-
	97 9 035575		PN16				6,80	12,03		
76	97 8 035590	355/90	PN10	450,00	180,00	21,10	5,40	9,90	-	-
	97 9 035590		PN16				8,20	15,21		
77	97 8 355110	355/110	PN10	450,00	180,00	21,10	6,60	10,11	-	-
	97 9 355110		PN16				10,00	15,52		
78	97 8 355125	355/125	PN10	450,00	180,00	21,10	7,40	10,30	-	-
	97 9 355125		PN16				11,40	15,82		
79	97 8 355140	355/140	PN10	500,00	200,00	21,10	8,30	11,66	-	-
	97 9 355140		PN16				12,70	17,88		
80	97 8 355160	355/160	PN10	550,00	200,00	21,10	9,50	13,10	-	-
	97 9 355160		PN16				14,60	20,08		
81	97 8 355180	355/180	PN10	550,00	200,00	21,10	10,70	13,55	-	-
	97 9 355180		PN16				16,40	20,74		
82	97 8 355200	355/200	PN10	600,00	220,00	21,10	11,90	15,27	-	-
	97 9 355200		PN16				18,20	23,35		
83	97 8 355225	355/225	PN10	650,00	220,00	21,10	13,40	17,13	-	-
	97 9 355225		PN16				20,50	26,14		
84	97 8 355250	355/250	PN10	650,00	220,00	21,10	14,80	18,06	-	-
	97 9 355250		PN16				22,70	27,52		
85	97 8 355280	355/280	PN10	700,00	240,00	21,10	16,60	20,66	-	-
	97 9 355280		PN16				25,40	31,48		
86	97 8 355315	355/315	PN10	750,00	240,00	21,10	18,70	23,61	-	-
	97 9 355315		PN16				28,60	35,83		
87	97 8 040063	400/63	PN10	360,00	140,00	23,70	3,80	10,24	-	-
	97 9 040063		PN16				5,80	15,10		
88	97 8 040075	400/75	PN10	360,00	140,00	23,70	4,50	10,31	-	-
	97 9 040075		PN16				6,80	15,20		

water / gas

KONFEKSİYON İNEGAL ÇATAL - SEGMENTED SPECIAL DEGREE REDUCED TEE
TÉ 45° RÉDUIT SEGMENTÉ / НЕ РАВНОПРОХОДНОЙ КОСОЙТРОЙНИК 45° (Сварной) / فرع 45° درجة غير متساوية (ملفقة)
PE100 - SDR 17 - PN10 ve SDR 11 - PN16

SIRA	ÜRÜN KODU	ÇAP d [mm]	BASINÇ [bar]	L [mm]	L ₁ [mm]	z [mm]	e [mm]	AĞIRLIK [kg]	KOLİ ADEDİ	KOLİ EBATI
SEQ	PRODUCT CODE	SIZE d [mm]	PRESSURE [bar]					WEIGHT [kg]	IN A PARCEL	PCS PRICE
89	97 8 040090	400/90	PN10	450,00	180,00	23,70	5,40	13,00	-	-
	97 9 040090		PN16				8,20	19,17		
90	97 8 400110	400/110	PN10	450,00	180,00	23,70	6,60	13,22	-	-
	97 9 400110		PN16				10,00	19,48		
91	97 8 400125	400/125	PN10	450,00	180,00	23,70	7,40	13,40	-	-
	97 9 400125		PN16				11,40	19,78		
92	97 8 400140	400/140	PN10	500,00	200,00	23,70	8,30	15,11	-	-
	97 9 400140		PN16				12,70	22,28		
93	97 8 400160	400/160	PN10	550,00	200,00	23,70	9,50	16,89	-	-
	97 9 400160		PN16				14,60	24,92		
94	97 8 400180	400/180	PN10	550,00	200,00	23,70	10,70	17,34	-	-
	97 9 400180		PN16				16,40	25,58		
95	97 8 400200	400/200	PN10	600,00	220,00	23,70	11,90	19,41	-	-
	97 9 400200		PN16				18,20	28,63		
96	97 8 400225	400/225	PN10	650,00	220,00	23,70	13,40	21,62	-	-
	97 9 400225		PN16				20,50	31,86		
97	97 8 400250	400/250	PN10	650,00	220,00	23,70	14,80	22,55	-	-
	97 9 400250		PN16				22,70	33,24		
98	97 8 400280	400/280	PN10	700,00	240,00	23,70	16,60	25,49	-	-
	97 9 400280		PN16				25,40	37,64		
99	97 8 400315	400/315	PN10	750,00	240,00	23,70	18,70	28,79	-	-
	97 9 400315		PN16				28,60	42,43		
100	97 8 400355	400/355	PN10	800,00	240,00	23,70	21,10	32,73	-	-
	97 9 400355		PN16				32,20	48,23		
101	97 8 045063	450/63	PN10	360,00	140,00	26,70	3,80	12,90	-	-
	97 9 045063		PN16				5,80	19,06		
102	97 8 045075	450/75	PN10	360,00	140,00	26,70	4,50	12,98	-	-
	97 9 045075		PN16				6,80	19,16		
103	97 8 045090	450/90	PN10	450,00	180,00	26,70	5,40	16,33	-	-
	97 9 045090		PN16				8,20	24,12		
104	97 8 450110	450/110	PN10	450,00	180,00	26,70	6,60	16,55	-	-
	97 9 450110		PN16				10,00	24,43		
105	97 8 450125	450/125	PN10	450,00	180,00	26,70	7,40	16,73	-	-
	97 9 450125		PN16				11,40	24,73		
106	97 8 450140	450/140	PN10	500,00	200,00	26,70	8,30	18,81	-	-
	97 9 450140		PN16				12,70	27,78		
107	97 8 450160	450/160	PN10	550,00	200,00	26,70	9,50	20,96	-	-
	97 9 450160		PN16				14,60	30,97		
108	97 8 450180	450/180	PN10	550,00	200,00	26,70	10,70	21,41	-	-
	97 9 450180		PN16				16,40	31,63		

water / gas

"Yıldız bize, Biz Su'ya yön gösteriyoruz..."
 "The stars show us the way, we show way to the water..."

www.yildizpolietilen.com



KONFEKSİYON İNEGAL ÇATAL - SEGMENTED SPECIAL DEGREE REDUCED TEE

TÉ 45° RÉDUIT SEGMENTÉ / НЕ РАВНОПРОХОДНОЙ КОСОЙТРОЙНИК 45° (Сварной) / فرع 45° درجة غير متساوية (ملفقة)
 PE100 - SDR 17 - PN10 ve SDR 11 - PN16

SIRA	ÜRÜN KODU	ÇAP d [mm]	BASINÇ [bar]	L [mm]	L ₁ [mm]	z [mm]	e [mm]	AĞIRLIK [kg]	KOLİ ADEDİ	KOLİ EBATI
SEQ.	PRODUCT CODE	SIZE d [mm]	PRESSURE [bar]					WEIGHT [kg]	IN A PARCEL	PCS PRICE
109	97 8 450200	450/200	PN10	600,00	220,00	26,70	11,90	23,85	-	-
	97 9 450200		PN16				18,20	35,23		
110	97 8 450225	450/225	PN10	650,00	220,00	26,70	13,40	26,43	-	-
	97 9 450225		PN16				20,50	39,01		
111	97 8 450250	450/250	PN10	650,00	220,00	26,70	14,80	27,36	-	-
	97 9 450250		PN16				22,70	40,39		
112	97 8 450280	450/280	PN10	700,00	240,00	26,70	16,60	30,67	-	-
	97 9 450280		PN16				25,40	45,34		
113	97 8 450315	450/315	PN10	750,00	240,00	26,70	18,70	34,34	-	-
	97 9 450315		PN16				28,60	50,68		
114	97 8 450355	450/355	PN10	800,00	240,00	26,70	21,10	38,65	-	-
	97 9 450355		PN16				32,20	57,03		
115	97 8 450400	450/400	PN10	850,00	260,00	26,70	23,70	44,37	-	-
	97 9 450400		PN16				36,30	65,52		
116	97 8 050063	500/63	PN10	400,00	140,00	29,70	3,80	17,68	-	-
	97 9 050063		PN16				5,80	26,03		
117	97 8 050075	500/75	PN10	400,00	140,00	29,70	4,50	17,75	-	-
	97 9 050075		PN16				6,80	26,13		
118	97 8 050090	500/90	PN10	450,00	180,00	29,70	5,40	20,11	-	-
	97 9 050090		PN16				8,20	29,61		
119	97 8 500110	500/110	PN10	450,00	180,00	29,70	6,60	20,33	-	-
	97 9 500110		PN16				10,00	29,92		
120	97 8 500125	500/125	PN10	450,00	180,00	29,70	7,40	20,51	-	-
	97 9 500125		PN16				11,40	30,22		
121	97 8 500140	500/140	PN10	500,00	200,00	29,70	8,30	23,01	-	-
	97 9 500140		PN16				12,70	33,88		
122	97 8 500160	500/160	PN10	550,00	200,00	29,70	9,50	25,58	-	-
	97 9 500160		PN16				14,60	37,68		
123	97 8 500180	500/180	PN10	550,00	200,00	29,70	10,70	26,03	-	-
	97 9 500180		PN16				16,40	38,34		
124	97 8 500200	500/200	PN10	600,00	220,00	29,70	11,90	28,89	-	-
	97 9 500200		PN16				18,20	42,55		
125	97 8 500225	500/225	PN10	650,00	220,00	29,70	13,40	31,89	-	-
	97 9 500225		PN16				20,50	46,94		
126	97 8 500250	500/250	PN10	650,00	220,00	29,70	14,80	32,82	-	-
	97 9 500250		PN16				22,70	48,32		
127	97 8 500280	500/280	PN10	700,00	240,00	29,70	16,60	36,55	-	-
	97 9 500280		PN16				25,40	53,88		
128	97 8 500315	500/315	PN10	750,00	240,00	29,70	18,70	40,64	-	-
	97 9 500315		PN16				28,60	59,83		

water / gas

KONFEKSİYON İNEĞAL ÇATAL - SEGMENTED SPECIAL DEGREE REDUCED TEE

TÉ 45° RÉDUIT SEGMENTÉ / НЕ РАВНОПРОХОДНОЙ КОСОЙТРОЙНИК 45° (Сварной) / فرع 45° درجة غير متساوية (ملفقة)

PE100 - SDR 17 - PN10 ve SDR 11 - PN16

water / gas

SIRA	ÜRÜN KODU	ÇAP d [mm]	BASINÇ [bar]	L [mm]	L ₁ [mm]	z [mm]	e [mm]	AĞIRLIK [kg]	KOLİ ADEDİ	KOLİ EBATI
SEQ	PRODUCT CODE	SIZE d [mm]	PRESSURE [bar]					WEIGHT [kg]	IN A PARCEL	PCS PRICE
129	97 8 500355	500/355	PN10	800,00	240,00	29,70	21,10	45,37	-	-
	97 9 500355		PN16				32,20	66,79		
130	97 8 500400	500/400	PN10	850,00	260,00	29,70	23,70	51,51	-	-
	97 9 500400		PN16				36,30	75,89		
131	97 8 500450	500/450	PN10	900,00	260,00	29,70	26,70	58,36	-	-
	97 9 500450		PN16				40,90	86,03		
132	97 8 056063	560/63	PN10	400,00	140,00	33,20	3,80	22,08	-	-
	97 9 056063		PN16				5,80	32,55		
133	97 8 056075	560/75	PN10	400,00	140,00	33,20	4,50	22,15	-	-
	97 9 056075		PN16				6,80	32,65		
134	97 8 056090	560/90	PN10	450,00	180,00	33,20	5,40	25,06	-	-
	97 9 056090		PN16				8,20	36,94		
135	97 8 560110	560/110	PN10	450,00	180,00	33,20	6,60	25,28	-	-
	97 9 560110		PN16				10,00	37,25		
136	97 8 560125	560/125	PN10	450,00	180,00	33,20	7,40	25,46	-	-
	97 9 560125		PN16				11,40	37,55		
137	97 8 560140	560/140	PN10	500,00	200,00	33,20	8,30	28,51	-	-
	97 9 560140		PN16				12,70	42,03		
138	97 8 560160	560/160	PN10	550,00	200,00	33,20	9,50	31,63	-	-
	97 9 560160		PN16				14,60	46,64		
139	97 8 560180	560/180	PN10	550,00	200,00	33,20	10,70	32,08	-	-
	97 9 560180		PN16				16,40	47,30		
140	97 8 560200	560/200	PN10	600,00	220,00	33,20	11,90	35,49	-	-
	97 9 560200		PN16				18,20	52,33		
141	97 8 560225	560/225	PN10	650,00	220,00	33,20	13,40	39,04	-	-
	97 9 560225		PN16				20,50	57,53		
142	97 8 560250	560/250	PN10	650,00	220,00	33,20	14,80	39,97	-	-
	97 9 560250		PN16				22,70	58,92		
143	97 8 560280	560/280	PN10	700,00	240,00	33,20	16,60	44,25	-	-
	97 9 560280		PN16				25,40	65,29		
144	97 8 560315	560/315	PN10	750,00	240,00	33,20	18,70	48,89	-	-
	97 9 560315		PN16				28,60	72,06		
145	97 8 560355	560/355	PN10	800,00	240,00	33,20	21,10	54,17	-	-
	97 9 560355		PN16				32,20	79,83		
146	97 8 560400	560/400	PN10	850,00	260,00	33,20	23,70	60,86	-	-
	97 9 560400		PN16				36,30	89,74		
147	97 8 560450	560/450	PN10	900,00	260,00	33,20	26,70	68,26	-	-
	97 9 560450		PN16				40,90	100,70		
148	97 8 560500	560/500	PN10	1000,00	280,00	33,20	29,70	80,20	-	-
	97 9 560500		PN16				45,40	118,21		

"Yıldız bize, Biz Su'ya yön gösteriyoruz..."
 "The stars show us the way, we show way to the water..."

www.yildizpolietilen.com



KONFEKSİYON İNEGAL ÇATAL - SEGMENTED SPECIAL DEGREE REDUCED TEE

TÉ 45° RÉDUIT SEGMENTÉ / НЕ РАВНОПРОХОДНОЙ КОСОЙТРОЙНИК 45° (Сварной) / فرع 45° درجة غير متساوية (ملفقة)

PE100 - SDR 17 - PN10 ve SDR 11 - PN16

SIRA	ÜRÜN KODU	ÇAP d [mm]	BASINÇ [bar]	L [mm]	L ₁ [mm]	z [mm]	e [mm]	AĞIRLIK [kg]	KOLİ ADEDİ	KOLİ EBATI
SEQ	PRODUCT CODE	SIZE d [mm]	PRESSURE [bar]					WEIGHT [kg]	IN A PARCEL	PCS PRICE
149	97 8 063063	630/63	PN10	400,00	140,00	37,40	3,80	27,92	-	-
	97 9 063063		PN16					41,03		
150	97 8 063075	630/75	PN10	400,00	140,00	37,40	4,50	27,99	-	-
	97 9 063075		PN16					41,13		
151	97 8 063090	630/90	PN10	450,00	180,00	37,40	5,40	31,63	-	-
	97 9 063090		PN16					46,48		
152	97 8 630110	630/110	PN10	450,00	180,00	37,40	6,60	31,85	-	-
	97 9 630110		PN16					46,79		
153	97 8 630125	630/125	PN10	450,00	180,00	37,40	7,40	32,03	-	-
	97 9 630125		PN16					47,09		
154	97 8 630140	630/140	PN10	500,00	200,00	37,40	8,30	35,81	-	-
	97 9 630140		PN16					52,63		
155	97 8 630160	630/160	PN10	550,00	200,00	37,40	9,50	39,66	-	-
	97 9 630160		PN16					58,30		
156	97 8 630180	630/180	PN10	550,00	200,00	37,40	10,70	40,11	-	-
	97 9 630180		PN16					58,96		
157	97 8 630200	630/200	PN10	600,00	220,00	37,40	11,90	44,25	-	-
	97 9 630200		PN16					65,05		
158	97 8 630225	630/225	PN10	650,00	220,00	37,40	13,40	48,53	-	-
	97 9 630225		PN16					71,31		
159	97 8 630250	630/250	PN10	650,00	220,00	37,40	14,80	49,46	-	-
	97 9 630250		PN16					72,70		
160	97 8 630280	630/280	PN10	700,00	240,00	37,40	16,60	54,47	-	-
	97 9 630280		PN16					80,13		
161	97 8 630315	630/315	PN10	750,00	240,00	37,40	18,70	59,84	-	-
	97 9 630315		PN16					87,96		
162	97 8 630355	630/355	PN10	800,00	240,00	37,40	21,10	65,85	-	-
	97 9 630355		PN16					96,79		
163	97 8 630400	630/400	PN10	850,00	260,00	37,40	23,70	73,27	-	-
	97 9 630400		PN16					107,76		
164	97 8 630450	630/450	PN10	900,00	260,00	37,40	26,70	81,40	-	-
	97 9 630450		PN16					119,78		
165	97 8 630500	630/500	PN10	1000,00	280,00	37,40	29,70	94,80	-	-
	97 9 630500		PN16					139,41		
166	97 8 630560	630/560	PN10	1050,00	280,00	37,40	33,20	106,30	-	-
	97 9 630560		PN16					156,39		
167	97 8 071063	710/63	PN10	400,00	140,00	42,10	3,80	35,40	-	-
	97 9 071063		PN16					52,23		
168	97 8 071075	710/75	PN10	400,00	140,00	42,10	4,50	35,47	-	-
	97 9 071075		PN16					52,33		

water / gas

KONFEKSİYON İNEGAL ÇATAL - SEGMENTED SPECIAL DEGREE REDUCED TEE
 TÉ 45° RÉDUIT SEGMENTÉ / НЕ РАВНОПРОХОДНОЙ КОСОЙТРОЙНИК 45° (Сварной) / فرع 45° درجة غير متساوية (ملفقة)
 PE100 - SDR 17 - PN10 ve SDR 11 - PN16

water / gas

SIRA	ÜRÜN KODU	ÇAP d [mm]	BASINÇ [bar]	L [mm]	L ₁ [mm]	z [mm]	e [mm]	AĞIRLIK [kg]	KOLİ ADEDİ	KOLİ EBATI
SEQ.	PRODUCT CODE	SIZE d [mm]	PRESSURE [bar]					WEIGHT [kg]	IN A PARCEL	PCS PRICE
169	97 8 071090	710/90	PN10	450,00	180,00	42,10	5,40	40,05	-	-
	97 9 071090		PN16				8,20	59,08		
170	97 8 710110	710/110	PN10	450,00	180,00	42,10	6,60	40,26	-	-
	97 9 710110		PN16				10,00	59,39		
171	97 8 710125	710/125	PN10	450,00	180,00	42,10	7,40	40,45	-	-
	97 9 710125		PN16				11,40	59,69		
172	97 8 710140	710/140	PN10	500,00	200,00	42,10	8,30	45,16	-	-
	97 9 710140		PN16				12,70	66,63		
173	97 8 710160	710/160	PN10	550,00	200,00	42,10	9,50	49,95	-	-
	97 9 710160		PN16				14,60	73,70		
174	97 8 710180	710/180	PN10	550,00	200,00	42,10	10,70	50,40	-	-
	97 9 710180		PN16				16,40	74,36		
175	97 8 710200	710/200	PN10	600,00	220,00	42,10	11,90	55,47	-	-
	97 9 710200		PN16				18,20	81,85		
176	97 8 710225	710/225	PN10	650,00	220,00	42,10	13,40	60,68	-	-
	97 9 710225		PN16				20,50	89,51		
177	97 8 710250	710/250	PN10	650,00	220,00	42,10	14,80	61,61	-	-
	97 9 710250		PN16				22,70	90,90		
178	97 8 710280	710/280	PN10	700,00	240,00	42,10	16,60	67,56	-	-
	97 9 710280		PN16				25,40	99,73		
179	97 8 710315	710/315	PN10	750,00	240,00	42,10	18,70	73,86	-	-
	97 9 710315		PN16				28,60	108,96		
180	97 8 710355	710/355	PN10	800,00	240,00	42,10	21,10	80,81	-	-
	97 9 710355		PN16				32,20	119,19		
181	97 8 710400	710/400	PN10	850,00	260,00	42,10	23,70	89,17	-	-
	97 9 710400		PN16				36,30	131,56		
182	97 8 710450	710/450	PN10	900,00	260,00	42,10	26,70	98,23	-	-
	97 9 710450		PN16				40,90	144,98		
183	97 8 710500	710/500	PN10	1000,00	280,00	42,10	29,70	113,50	-	-
	97 9 710500		PN16				45,40	167,41		
184	97 8 710560	710/560	PN10	1050,00	300,00	42,10	33,20	127,03	-	-
	97 9 710560		PN16				50,80	187,40		
185	97 8 710630	710/630	PN10	1100,00	320,00	42,10	37,40	144,45	-	-
	97 9 710630		PN16				57,20	212,87		
186	97 8 080090	800/90	PN10	450,00	180,00	47,40	5,40	50,80	-	-
	97 9 080090		PN16				8,20	76,63		
187	97 8 800110	800/110	PN10	480,00	180,00	47,40	6,60	54,38	-	-
	97 9 800110		PN16				10,00	82,01		
188	97 8 800125	800/125	PN10	450,00	180,00	47,40	7,40	51,20	-	-
	97 9 800125		PN16				11,40	77,24		

"Yıldız bize, Biz Su'ya yön gösteriyoruz..."
 "The stars show us the way, we show way to the water..."

www.yildizpolietilen.com



KONFEKSİYON İNEGAL ÇATAL - SEGMENTED SPECIAL DEGREE REDUCED TEE

TÉ 45° RÉDUIT SEGMENTÉ / НЕ РАВНОПРОХОДНОЙ КОСОЙТРОЙНИК 45° (Сварной) / فرع 45° درجة غير متساوية (ملفقة)
 PE100 - SDR 17 - PN10 ve SDR 11 - PN16

SIRA	ÜRÜN KODU	ÇAP d [mm]	BASINÇ [bar]	L [mm]	L ₁ [mm]	z [mm]	e [mm]	AĞIRLIK [kg]	KOLİ ADEDİ	KOLİ EBATI
SEQ	PRODUCT CODE	SIZE d [mm]	PRESSURE [bar]					WEIGHT [kg]	IN A PARCEL	PCS PRICE
189	97 8 800140	800/140	PN10	500,00	200,00	47,40	8,30	57,11	-	-
	97 9 800140		PN16				12,70	86,13		
190	97 8 800160	800/160	PN10	550,00	200,00	47,40	9,50	63,09	-	-
	97 9 800160		PN16				14,60	95,15		
191	97 8 800180	800/180	PN10	550,00	200,00	47,40	10,70	63,54	-	-
	97 9 800180		PN16				16,40	95,81		
192	97 8 800200	800/200	PN10	600,00	220,00	47,40	11,90	69,81	-	-
	97 9 800200		PN16				18,20	105,25		
193	97 8 800225	800/225	PN10	650,00	220,00	47,40	13,40	76,22	-	-
	97 9 800225		PN16				20,50	114,86		
194	97 8 800250	800/250	PN10	650,00	220,00	47,40	14,80	77,15	-	-
	97 9 800250		PN16				22,70	116,25		
195	97 8 800280	800/280	PN10	700,00	240,00	47,40	16,60	84,29	-	-
	97 9 800280		PN16				25,40	127,03		
196	97 8 800315	800/315	PN10	750,00	240,00	47,40	18,70	91,79	-	-
	97 9 800315		PN16				28,60	138,21		
197	97 8 800355	800/355	PN10	800,00	240,00	47,40	21,10	99,93	-	-
	97 9 800355		PN16				32,20	150,39		
198	97 8 800400	800/400	PN10	850,00	260,00	47,40	23,70	109,48	-	-
	97 9 800400		PN16				36,30	164,71		
199	97 8 800450	800/450	PN10	900,00	260,00	47,40	26,70	119,74	-	-
	97 9 800450		PN16				40,90	180,08		
200	97 8 800500	800/500	PN10	1000,00	280,00	47,40	29,70	137,40	-	-
	97 9 800500		PN16				45,40	206,41		
201	97 8 800560	800/560	PN10	1050,00	300,00	47,40	33,20	152,12	-	-
	97 9 800560		PN16				50,80	228,35		
202	97 8 800630	800/630	PN10	1100,00	320,00	47,40	37,40	170,74	-	-
	97 9 800630		PN16				57,20	255,77		
203	97 8 800710	800/710	PN10	1200,00	340,00	47,40	42,10	200,03	-	-
	97 9 800710		PN16				64,50	299,65		
204	97 8 900110	900/110	PN10	450,00	180,00	53,30	6,60	64,07	-	-
	97 9 900110		PN16				10,00	95,39		
205	97 8 900125	900/125	PN10	450,00	180,00	53,30	7,40	64,25	-	-
	97 9 900125		PN16				11,40	95,69		
206	97 8 900140	900/140	PN10	500,00	200,00	53,30	8,30	71,61	-	-
	97 9 900140		PN16				12,70	106,63		
207	97 8 900160	900/160	PN10	550,00	200,00	53,30	9,50	79,04	-	-
	97 9 900160		PN16				14,60	117,70		
208	97 8 900180	900/180	PN10	550,00	200,00	53,30	10,70	79,49	-	-
	97 9 900180		PN16				16,40	118,36		

water / gas

KONFEKSİYON İNEGAL ÇATAL - SEGMENTED SPECIAL DEGREE REDUCED TEE
 T  45  R DUIT SEGMENT  / HE PABHOPPOXOAHNOY KOCOTPOYHNK 45  (CwapH ) / فرع 45  درجه غير متساوية (ملفقة)
 PE100 - SDR 17 - PN10 ve SDR 11 - PN16

water / gas

SIRA	�R�N KODU	�AP d [mm]	BASIN� [bar]	L [mm]	L ₁ [mm]	z [mm]	e [mm]	AĐIRLIK [kg]	KOLİ ADEDİ	KOLİ EBATI
SEQ	PRODUCT CODE	SIZE d [mm]	PRESSURE [bar]					WEIGHT [kg]	IN A PARCEL	PCS PRICE
209	97 8 900200	900/200	PN10	600,00	220,00	53,30	11,90	87,21	-	-
	97 9 900200		PN16				18,20	129,85		
210	97 8 900225	900/225	PN10	650,00	220,00	53,30	13,40	95,07	-	-
	97 9 900225		PN16				20,50	141,51		
211	97 8 900250	900/250	PN10	650,00	220,00	53,30	14,80	96,00	-	-
	97 9 900250		PN16				22,70	142,90		
212	97 8 900280	900/280	PN10	700,00	240,00	53,30	16,60	104,59	-	-
	97 9 900280		PN16				25,40	155,73		
213	97 8 900315	900/315	PN10	700,00	240,00	53,30	18,70	106,49	-	-
	97 9 900315		PN16				28,60	158,46		
214	97 8 900355	900/355	PN10	800,00	240,00	53,30	21,10	123,13	-	-
	97 9 900355		PN16				32,20	183,19		
215	97 8 900400	900/400	PN10	850,00	260,00	53,30	23,70	134,13	-	-
	97 9 900400		PN16				36,30	199,56		
216	97 8 900450	900/450	PN10	900,00	260,00	53,30	26,70	145,84	-	-
	97 9 900450		PN16				40,90	216,98		
217	97 8 900500	900/500	PN10	1000,00	280,00	53,30	29,70	166,40	-	-
	97 9 900500		PN16				45,40	247,41		
218	97 8 900560	900/560	PN10	1060,00	300,00	53,30	33,20	183,98	-	-
	97 9 900560		PN16				50,80	273,50		
219	97 8 900630	900/630	PN10	1150,00	320,00	53,30	37,40	209,69	-	-
	97 9 900630		PN16				57,20	311,37		
220	97 8 900710	900/710	PN10	1200,00	340,00	53,30	42,10	234,83	-	-
	97 9 900710		PN16				64,50	348,85		
221	97 8 900800	900/800	PN10	1300,00	380,00	53,30	47,40	276,26	-	-
	97 9 900800		PN16				72,80	413,27		
222	97 8 990110	1000/110	PN10	450,00	180,00	59,30	6,60	79,37	-	-
	97 9 990110		PN16				10,00	117,44		
223	97 8 990125	1000/125	PN10	450,00	180,00	59,30	7,40	79,55	-	-
	97 9 990125		PN16				11,40	117,74		
224	97 8 990140	1000/140	PN10	500,00	200,00	59,30	8,30	88,61	-	-
	97 9 990140		PN16				12,70	131,13		
225	97 8 990160	1000/160	PN10	550,00	200,00	59,30	9,50	97,74	-	-
	97 9 990160		PN16				14,60	144,65		
226	97 8 990180	1000/180	PN10	550,00	200,00	59,30	10,70	98,19	-	-
	97 9 990180		PN16				16,40	145,31		
227	97 8 990200	1000/200	PN10	600,00	220,00	59,30	11,90	107,61	-	-
	97 9 990200		PN16				18,20	159,25		
228	97 8 990225	1000/225	PN10	650,00	220,00	59,30	13,40	117,17	-	-
	97 9 990225		PN16				20,50	173,36		

"Yıldız bize, Biz Su'ya yön gösteriyoruz..."
 "The stars show us the way, we show way to the water..."
 www.yildizpolietilen.com



KONFEKSİYON İNEĞAL ÇATAL - SEGMENTED SPECIAL DEGREE REDUCED TEE
 TÉ 45° RÉDUIT SEGMENTÉ / НЕ РАВНОПРОХОДНОЙ КОСОЙТРОЙНИК 45° (Сварной) / فرع 45° درجة غير متساوية (ملففة)
 PE100 - SDR 17 - PN10 ve SDR 11 - PN16

SIRA	ÜRÜN KODU	ÇAP d [mm]	BASINÇ [bar]	L [mm]	L ₁ [mm]	z [mm]	e [mm]	AĞIRLIK [kg]	KOLİ ADEDİ	KOLİ EBATİ
SEQ	PRODUCT CODE	SIZE d [mm]	PRESSURE [bar]					WEIGHT [kg]	IN A PARCEL	PCS PRICE
229	97 8 990250	1000/250	PN10	650,00	220,00	59,30	14,80	118,10	-	-
	97 9 990250		PN16				22,70	174,75		
230	97 8 990280	1000/280	PN10	700,00	240,00	59,30	16,60	128,39	-	-
	97 9 990280		PN16				25,40	190,03		
231	97 8 990315	1000/315	PN10	750,00	240,00	59,30	18,70	139,04	-	-
	97 9 990315		PN16				28,60	205,71		
232	97 8 990355	1000/355	PN10	800,00	240,00	59,30	21,10	150,33	-	-
	97 9 990355		PN16				32,20	222,39		
233	97 8 990400	1000/400	PN10	850,00	260,00	59,30	23,70	163,03	-	-
	97 9 990400		PN16				36,30	241,21		
234	97 8 990450	1000/450	PN10	900,00	260,00	59,30	26,70	176,44	-	-
	97 9 990450		PN16				40,90	261,08		
235	97 8 990500	1000/500	PN10	1000,00	280,00	59,30	29,70	200,40	-	-
	97 9 990500		PN16				45,40	296,41		
236	97 8 990560	1000/560	PN10	1050,00	300,00	59,30	33,20	218,27	-	-
	97 9 990560		PN16				50,80	322,85		
237	97 8 990630	1000/630	PN10	1150,00	320,00	59,30	37,40	248,79	-	-
	97 9 990630		PN16				57,20	367,72		
238	97 8 990710	1000/710	PN10	1200,00	340,00	59,30	42,10	275,63	-	-
	97 9 990710		PN16				64,50	407,65		
239	97 8 990800	1000/800	PN10	1300,00	380,00	59,30	47,40	320,46	-	-
	97 9 990800		PN16				72,80	476,97		
240	97 8 990900	1000/900	PN10	1450,00	420,00	59,30	53,30	383,47	-	-
	97 9 990900		PN16				81,70	568,75		

water / gas

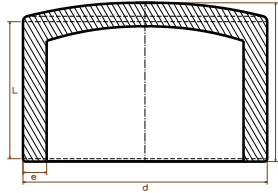

ENJEKSİYON KEP (KÖR TAPA)

INJECTION CAP

BOUCHON INJECTÉ / ЗАГЛУШКА (ЛитоЙ) / سدادة (حقن)

PE100 - SDR 17 - PN10 ve SDR 11 - PN16

SIRA SEQ.	ÜRÜN KODU PRODUCT CODE	ÇAP d [mm] SIZE d [mm]	BASINÇ [bar] PRESSURE [bar]	z [mm]	L [mm]	e [mm]	AĞIRLIK [kg] WEIGHT [kg]	KOLİ ADEDİ IN A PARCEL	KOLİ EBATİ PCS PRICE
1	97 3 312002	20	PN16	39,95	36,95	2,30	0,01	1600,00	41/60/31
2	97 3 312002	25	PN16	47,75	43,75	2,70	0,01	1400,00	41/60/31
3	97 3 312003	32	PN10	44,50	37,75	2,30	0,01	900,00	41/60/31
	97 4 312003		PN16			3,40	0,01		
4	97 3 312004	40	PN10	49,00	42,10	2,80	0,02	600,00	41/60/31
	97 4 312004		PN16			4,20	0,03		
5	97 3 312005	50	PN10	60,00	54,00	3,20	0,03	320,00	41/60/31
	97 4 312005		PN16			4,60	0,04		
6	97 3 312006	63	PN10	67,50	64,00	4,21	0,06	220,00	41/60/31
	97 4 312006		PN16			6,50	0,09		
7	97 3 312007	75	PN10	66,00	63,00	4,72	0,08	150,00	41/60/31
	97 4 312007		PN16			7,30	0,12		
8	97 3 312009	90	PN10	81,00	77,00	5,69	0,15	90,00	41/60/31
	97 4 312009		PN16			8,80	0,23		
9	97 3 312011	110	PN10	87,40	77,50	7,20	0,24	75,00	41/60/31
	97 4 312011		PN16			10,20	0,32		
10	97 3 312012	125	PN10	110,00	100,00	7,89	0,34	36,00	41/60/31
	97 4 312012		PN16			12,20	0,51		
11	97 3 312014	140	PN10	115,00	106,55	8,54	0,47	36,00	41/60/37
	97 4 312014		PN16			13,20	0,70		
12	97 3 312016	160	PN10	120,00	106,50	9,60	0,58	24,00	41/60/37
	97 4 312016		PN16			14,60	0,87		
13	97 3 312018	180	PN10	133,00	119,20	10,80	1,06	18,00	41/60/37
	97 4 312018		PN16			16,40	1,59		
14	97 3 312020	200	PN10	130,00	118,14	12,49	1,08	12,00	41/60/31
	97 4 312020		PN16			19,30	1,62		
15	97 3 312022	225	PN10	148,00	137,35	14,64	1,86	7,00	41/60/31
	97 4 312022		PN16			22,70	2,43		
16	97 3 312025	250	PN10	137,00	129,30	17,60	1,93	6,00	41/60/31
	97 4 312025		PN16			25,00	2,89		
17	97 3 312028	280	PN10	143,00	139,00	17,60	2,65	6,00	41/60/31
	97 4 312028		PN16			27,20	3,97		
18	97 3 312031	315	PN10	101,20	93,20	19,54	2,55	6,00	41/60/37
	97 4 312031		PN16			30,20	3,83		
19	97 3 312035	355	PN10	110,00	90,60	22,40	3,68	5,00	41/60/37
	97 4 312035		PN16			35,60	5,52		
20	97 3 312040	400	PN10	110,00	98,00	25,88	4,42	4,00	41/60/37
	97 4 312040		PN16			40,00	6,63		
21	97 3 312050	500	PN10	135,00	111,00	31,00	8,07	4,00	50/60/50
	97 4 312050		PN16			50,10	12,11		



YILDIZ
for the best
Polietilen

Ø 32 [mm] - Ø1600 [mm]

REDÜKSİYON - REDUCER

RÉDUCTION / ПЕРЕХОДНИК / تخفيض



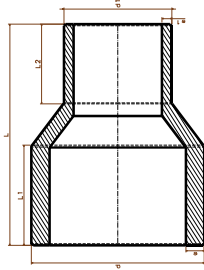

ENJEKSİYON REDÜKSİYON INJECTION REDUCER

RÉDUCTION INJECTÉ / ПЕРЕХОДНИК (Литой) / تخفيض (حقن)
PE100 - SDR 17 - PN10 ve SDR 11 - PN16

water / gas

SIRA	ÜRÜN KODU	ÇAP d/d1 [mm]	BASINÇ [bar]	L [mm]	L ₁ [mm]	L ₂ [mm]	e [mm]	e ₁ [mm]	AĞIRLIK [kg]	KOLİ ADEDİ	KOLİ EBATI
SEQ.	PRODUCT CODE	SIZE d/d1 [mm]	PRESSURE [bar]						WEIGHT [kg]	IN A PARCEL	PCS PRICE
1	97 6 602520	25/20	PN10	90,00	43,00	33,00	2,70	2,30	0,02	1200	41/60/31
2	97 6 603220	32/20	PN10	84,60	38,65	36,00	3,40	2,30	0,02	900	41/60/31
3	97 6 603225	32/25	PN10	83,50	37,40	35,30	3,30	2,70	0,02	800	41/60/31
4	97 6 604032	40/32	PN10	89,90	42,00	34,09	2,60	2,10	0,03	400	41/60/31
	PN16		4,20				3,40	0,04			
5	97 6 605032	50/32	PN10	110,53	52,28	48,00	3,10	2,20	0,04	230	41/60/31
	PN16		5,00				3,40	0,06			
6	97 6 605040	50/40	PN10	115,80	62,00	49,00	3,20	2,50	0,05	140	41/60/31
	PN16		5,20				4,00	0,07			
7	97 6 606332	63/32	PN10	125,00	63,00	40,00	4,00	2,30	0,07	210	41/60/31
	PN16		6,50				3,40	0,11			
8	97 6 606340	63/40	PN10	134,55	71,07	42,00	4,10	2,50	0,07	210	41/60/31
	PN16		6,50				4,15	0,11			
9	97 6 606350	63/50	PN10	150,20	69,80	63,76	4,20	3,20	0,10	120	41/60/31
	PN16		6,50				5,10	0,15			
10	97 6 607532	75/32	PN10	152,00	74,00	52,00	4,70	2,30	0,11	120	41/60/31
	PN16		7,60				3,40	0,16			
11	97 6 607540	75/40	PN10	152,00	74,00	56,00	4,90	2,80	0,11	120	41/60/31
	PN16		7,60				4,20	0,17			
12	97 6 607550	75/50	PN10	149,80	75,00	58,50	5,00	3,40	0,13	120	41/60/31
	PN16		7,60				5,20	0,19			
13	97 6 607563	75/63	PN10	158,60	80,36	64,15	5,00	4,10	0,15	75	41/60/31
	PN16		7,60				5,80	0,22			
14	97 6 609032	90/32	PN10	152,60	80,00	48,00	5,80	2,30	0,17	72	41/60/31
	PN16		9,20				3,40	0,25			
15	97 6 609040	90/40	PN10	150,00	71,80	56,20	5,80	2,60	0,15	72	41/60/31
	PN16		9,20				4,00	0,23			
16	97 6 609050	90/50	PN10	160,50	80,44	61,40	5,90	3,20	0,18	72	41/60/31
	PN16		9,20				5,00	0,27			
17	97 6 609063	90/63	PN10	167,00	83,00	68,00	6,00	4,20	0,21	70	41/60/31
	PN16		9,20				6,20	0,31			
18	97 6 609075	90/75	PN10	164,60	85,60	72,00	6,00	4,90	0,23	42	41/60/31
	PN16		9,20				7,60	0,34			

"Yıldız bize, Biz Su'ya yön gösteriyoruz..."
 "The stars show us the way, we show way to the water..."

www.yildizpolietilen.com



ENJEKSİYON REDÜKSİYON - INJECTION REDUCER - RÉDUCTION INJECTÉ / ПЕРЕХОДНИК (Литой) / تخفيض (حقن)
 PE100 - SDR 17 - PN10 ve SDR 11 - PN16

SIRA	ÜRÜN KODU	ÇAP d/d1 [mm]	BASINÇ [bar]	L [mm]	L ₁ [mm]	L ₂ [mm]	e [mm]	e ₁ [mm]	AĞIRLIK [kg]	KOLİ ADEDİ	KOLİ EBATI
SEQ	PRODUCT CODE	SIZE d/d1 [mm]	PRESSURE [bar]						WEIGHT [kg]	IN A PARCEL	PCS PRICE
19	97 6 611032	110/32	PN10	174,44	86,40	50,90	6,80	2,30	0,25	50	41/60/31
	97 5 611032		PN16								
20	97 6 611040	110/40	PN10	176,00	85,60	57,00	6,90	2,80	0,26	50	41/60/31
	97 5 611040		PN16								
21	97 6 611050	110/50	PN10	183,30	92,00	59,50	7,00	3,30	0,31	48	41/60/31
	97 5 611050		PN16								
22	97 6 611063	110/63	PN10	186,45	90,20	64,00	7,00	4,20	0,31	45	41/60/31
	97 5 611063		PN16								
23	97 6 611075	110/75	PN10	187,60	86,70	69,00	7,10	5,00	0,33	42	41/60/31
	97 5 611075		PN16								
24	97 6 611090	110/90	PN10	186,00	83,30	80,50	7,20	6,00	0,37	36	41/60/31
	97 5 611090		PN16								
25	97 6 612575	125/75	PN10	194,00	105,45	62,00	7,60	5,00	0,35	30	41/60/31
	97 5 612575		PN16								
26	97 6 612590	125/90	PN10	181,00	80,70	77,75	7,80	5,90	0,37	34	41/60/46
	97 5 612590		PN16								
27	97 6 6115110	125/110	PN10	195,80	89,00	88,60	8,00	6,80	0,48	34	41/60/46
	97 5 6115110		PN16								
28	97 6 614090	140/90	PN10	216,00	109,50	76,50	8,50	6,00	0,61	14	41/60/31
	97 5 614090		PN16								
29	97 6 690110	140/110	PN10	220,30	114,00	89,20	8,60	7,20	0,62	14	41/60/31
	97 5 690110		PN16								
30	97 6 690125	140/125	PN10	216,44	108,90	99,44	8,60	8,00	0,65	14	41/60/31
	97 5 690125		PN16								
31	97 6 616063	160/63	PN10	230,80	110,00	69,60	10,00	4,20	0,74	24	41/60/46
	97 5 616063		PN16								
32	97 6 616075	160/75	PN10	230,70	111,35	69,35	10,00	5,00	0,82	24	41/60/46
	97 5 616075		PN16								
33	97 6 616090	160/90	PN10	252,36	109,90	95,10	10,50	5,80	0,88	14	41/60/31
	97 5 616090		PN16								
34	97 6 689110	160/110	PN10	224,90	102,70	83,90	10,30	6,90	0,83	14	41/60/31
	97 5 689110		PN16								
35	97 6 689125	160/125	PN10	245,20	117,20	100,80	10,20	7,60	0,98	14	41/60/31
	97 5 689125		PN16								
36	97 6 689140	160/140	PN10	235,60	114,00	102,00	10,10	9,10	0,97	12	41/60/31
	97 5 689140		PN16								
37	97 6 618090	180/90	PN10	281,00	129,60	81,70	11,00	5,80	1,13	12	41/60/37
	97 5 618090		PN16								
38	97 6 688110	180/110	PN10	252,70	118,00	99,00	11,00	7,20	1,04	12	41/60/37
	97 5 688110		PN16								

water / gas

ENJEKSİYON REDÜKSİYON - INJECTION REDUCER - RÉDUCTION INJECTÉ / ПЕРЕХОДНИК (Литой) / تخفيض (حقن)
PE100 - SDR 17 - PN10 ve SDR 11 - PN16

SIRA	ÜRÜN KODU	ÇAP d/d1 [mm]	BASINÇ [bar]	L [mm]	L ₁ [mm]	L ₂ [mm]	e [mm]	e ₁ [mm]	AĞIRLIK [kg]	KOLİ ADEDİ	KOLİ EBATI
SEQ	PRODUCT CODE	SIZE d/d1 [mm]	PRESSURE [bar]						WEIGHT [kg]	IN A PARCEL	PCS PRICE
39	97 6 688125	180/125	PN10	278,40	130,45	94,00	11,20	8,00	1,30	12	41/60/37
	97 5 688125		PN16				18,20	12,60	1,95		
40	97 6 688140	180/140	PN10	253,10	121,84	111,60	11,10	8,80	1,23	12	41/60/37
	97 5 688140		PN16				18,20	14,10	1,85		
41	97 6 688160	180/160	PN10	251,70	116,80	100,44	11,30	10,00	1,29	8	41/60/37
	97 5 688160		PN16				17,52	14,60	1,93		
42	97 6 620090	200/90	PN10	278,56	125,90	98,00	12,00	5,80	1,27	12	41/60/46
	97 5 620090		PN16				20,20	8,70	1,91		
43	97 6 699110	200/110	PN10	283,26	131,24	101,30	12,20	6,80	1,41	12	41/60/46
	97 5 699110		PN16				20,20	10,80	2,11		
44	97 6 699125	200/125	PN10	281,60	126,40	100,80	12,30	8,00	1,45	12	41/60/46
	97 5 699125		PN16				20,20	11,50	2,17		
45	97 6 699140	200/140	PN10	287,00	128,00	113,00	12,50	9,00	1,48	12	41/60/46
	97 5 699140		PN16				20,20	12,80	2,22		
46	97 6 699160	200/160	PN10	274,00	127,87	111,00	12,50	10,00	1,65	10	41/60/46
	97 5 699160		PN16				20,20	15,20	2,48		
47	97 6 699180	200/180	PN10	278,75	135,76	104,50	13,00	11,60	1,86	10	41/60/46
	97 5 699180		PN16				19,30	18,00	2,79		
48	97 6 698110	225/110	PN10	290,60	145,85	100,45	14,50	7,20	1,79	8	41/60/46
	97 5 698110		PN16				21,20	10,80	2,69		
49	97 6 698125	225/125	PN10	306,45	151,20	111,00	14,40	8,10	1,94	8	41/60/46
	97 5 698125		PN16				20,60	12,70	2,91		
50	97 6 698140	225/140	PN10	301,40	153,20	102,70	14,60	8,60	2,11	8	41/60/46
	97 5 698140		PN16				21,60	14,10	3,16		
51	97 6 698160	225/160	PN10	300,00	151,00	106,00	14,60	10,20	2,23	6	41/60/46
	97 5 698160		PN16				21,50	15,80	3,34		
52	97 6 698180	225/180	PN10	299,00	150,83	108,90	14,80	10,90	2,18	6	41/60/46
	97 5 698180		PN16				22,70	16,40	3,27		
53	97 6 698200	225/200	PN10	302,70	155,10	118,00	14,00	12,10	2,43	6	41/60/46
	97 5 698200		PN16				20,70	20,50	3,65		
54	97 6 697110	250/110	PN10	276,40	96,40	114,00	15,00	7,20	1,80	12	50/60/50
	97 5 697110		PN16				23,20	11,00	2,70		
55	97 6 697125	250/125	PN10	265,00	95,00	114,00	15,40	8,00	1,80	12	50/60/50
	97 5 697125		PN16				23,00	12,10	2,70		
56	97 6 697140	250/140	PN10	267,67	89,12	108,20	15,60	9,10	1,96	12	50/60/50
	97 5 697140		PN16				23,50	12,90	2,94		
57	97 6 697160	250/160	PN10	272,00	96,27	111,50	15,80	10,20	2,16	12	50/60/50
	97 5 697160		PN16				22,70	14,90	3,24		
58	97 6 697180	250/180	PN10	273,00	96,50	113,80	16,00	11,60	2,27	12	50/60/50
	97 5 697180		PN16				22,70	16,60	3,40		

water / gas

"Yıldız bize, Biz Su'ya yön gösteriyoruz..."
 "The stars show us the way, we show way to the water..."
 www.yildizpolietilen.com



ENJEKSİYON REDÜKSİYON - INJECTION REDUCER - RÉDUCTION INJECTÉ / ПЕРЕХОДНИК (Литой) / تخفيض (حقن)
 PE100 - SDR 17 - PN10 ve SDR 11 - PN16

SIRA	ÜRÜN KODU	ÇAP d/d1 [mm]	BASINÇ [bar]	L [mm]	L ₁ [mm]	L ₂ [mm]	e [mm]	e ₁ [mm]	AĞIRLIK [kg]	KOLİ ADEDİ	KOLİ EBATI
SEQ	PRODUCT CODE	SIZE d/d1 [mm]	PRESSURE [bar]						WEIGHT [kg]	IN A PARCEL	PCS PRICE
59	97 6 697200	250/200	PN10	263,80	93,70	105,60	16,20	12,80	2,33	8	50/60/50
	97 5 697200		PN16				22,90	19,00	3,50		
60	97 6 697225	250/225	PN10	262,80	104,70	114,70	16,00	14,00	2,57	8	50/60/50
	97 5 697225		PN16				22,70	21,40	3,86		
61	97 6 696110	280/110	PN10	204,00	72,00	64,00	17,00	7,20	1,81	8	41/60/46
	97 5 696110		PN16				27,20	10,30	2,72		
62	97 6 696125	280/125	PN10	180,00	70,00	65,00	17,40	8,00	1,89	8	41/60/46
	97 5 696125		PN16				27,00	12,10	2,84		
63	97 6 696160	280/160	PN10	184,20	70,55	68,20	17,60	10,20	1,93	6	41/60/46
	97 5 696160		PN16				26,25	14,60	2,89		
64	97 6 696180	280/180	PN10	186,00	73,60	71,30	17,60	11,00	1,95	6	41/60/46
	97 5 696180		PN16				27,20	17,00	2,93		
65	97 6 696200	280/200	PN10	181,00	74,00	77,00	18,00	12,00	2,08	6	41/60/46
	97 5 696200		PN16				28,00	18,20	3,12		
66	97 6 696225	280/225	PN10	174,60	73,00	71,40	17,50	13,60	2,00	6	41/60/46
	97 5 696225		PN16				26,50	20,50	3,00		
67	97 6 696250	280/250	PN10	181,00	73,80	82,00	18,00	15,20	2,32	6	41/60/46
	97 5 696250		PN16				27,50	25,00	3,48		
68	97 6 695160	315/160	PN10	235,00	87,50	104,70	20,00	10,20	2,37	6	41/60/46
	97 5 695160		PN16				30,00	14,75	3,55		
69	97 6 695200	315/200	PN10	221,40	85,97	86,26	20,20	12,10	2,76	6	41/60/46
	97 5 695200		PN16				29,25	18,90	4,14		
70	97 6 695225	315/225	PN10	220,00	85,60	86,50	20,30	14,00	2,85	6	41/60/46
	97 5 695225		PN16				30,00	21,00	4,28		
71	97 6 695250	315/250	PN10	214,20	86,20	89,00	19,00	16,00	3,00	4	41/60/46
	97 5 695250		PN16				30,00	23,00	4,50		
72	97 6 695280	315/280	PN10	206,00	79,55	92,50	20,50	17,20	3,03	4	41/60/46
	97 5 695280		PN16				29,20	25,50	4,54		
73	97 6 694200	355/200	PN10	240,00	88,40	75,00	22,00	12,60	3,63	3	41/60/37
	97 5 694200		PN16				35,30	18,60	5,45		
74	97 6 694225	355/225	PN10	240,70	88,80	81,80	22,30	14,00	3,85	3	41/60/37
	97 5 694225		PN16				33,90	21,20	5,77		
75	97 6 694250	355/250	PN10	238,24	92,00	76,40	23,20	16,20	3,98	3	41/60/37
	97 5 694250		PN16				33,30	23,00	5,97		
76	97 6 694280	355/280	PN10	229,00	96,00	74,00	23,10	18,00	4,25	3	41/60/37
	97 5 694280		PN16				33,30	26,50	6,37		
77	97 6 694315	355/315	PN10	115,50	36,24	68,34	23,00	20,00	2,37	3	41/60/46
	97 5 694315		PN16				32,20	31,00	3,56		
78	97 6 693280	400/280	PN10	192,00	85,00	54,30	25,00	17,00	4,20	4	41/60/46
	97 5 693280		PN16				36,80	25,40	6,30		

water / gas

ENJEKSİYON REDÜKSİYON - INJECTION REDUCER - RÉDUCTION INJECTÉ / ПЕРЕХОДНИК (Литой) / تخفيض (حقن)
PE100 - SDR 17 - PN10 ve SDR 11 - PN16

SIRA	ÜRÜN KODU	ÇAP d/d1 [mm]	BASINÇ [bar]	L [mm]	L ₁ [mm]	L ₂ [mm]	e [mm]	e ₁ [mm]	AĞIRLIK [kg]	KOLİ ADEDİ	KOLİ EBATI
SEQ	PRODUCT CODE	SIZE d/d1 [mm]	PRESSURE [bar]						WEIGHT [kg]	IN A PARCEL	PCS PRICE
79	97 6 693315	400/315	PN10	193,10	90,57	65,00	25,30	20,00	4,40	4	41/60/46
	97 5 693315		PN16				36,60	29,60	6,60		
80	97 6 693355	400/355	PN10	190,50	90,20	77,20	25,90	22,60	4,34	3	41/60/46
	97 5 693355		PN16				36,93	32,70	6,51		
81	97 6 692250	450/250	PN10	257,00	102,90	87,50	28,60	15,60	6,07	2	41/60/46
	97 5 692250		PN16				41,50	22,70	9,10		
82	97 6 692280	450/280	PN10	260,00	104,16	91,10	29,00	18,00	6,44	2	41/60/46
	97 5 692280		PN16				42,60	26,10	9,66		
83	97 6 692315	450/315	PN10	220,30	87,40	67,20	29,00	20,00	6,87	2	41/60/46
	97 5 692315		PN16				42,30	29,30	10,30		
84	97 6 692355	450/355	PN10	252,00	107,25	90,30	28,60	23,10	7,32	2	41/60/46
	97 5 692355		PN16				41,00	33,40	10,98		
85	97 6 692400	450/400	PN10	241,88	96,80	99,90	29,00	26,00	7,33	2	50/60/50
	97 5 692400		PN16				42,30	36,40	11,00		
86	97 6 691315	500/315	PN10	233,00	77,45	67,70	31,00	20,50	7,17	3	50/60/50
	97 5 691315		PN16				46,50	30,00	10,76		
87	97 6 690500	560/500	PN10	400,00	150,00	150,00	32,00	29,00	20,20	-	-
	97 5 690500		PN16				51,00	45,20	28,30		
88	97 6 689560	630/560	PN10	400,00	150,00	150,00	37,20	31,80	25,30	-	-
	97 5 689560		PN16				57,00	50,40	30,20		
89	97 6 688630	710/630	PN10	160,00	40,00	50,00	42,00	36,90	13,00	-	-
	97 5 688630		PN16				64,20	56,80	19,00		
90	97 6 687710	800/710	PN10	150,00	60,00	60,00	47,20	41,90	16,00	-	-
	97 5 687710		PN16				72,50	64,60	22,90		

water / gas



YILDIZ
for the best
Polietilen

Ø 32 [mm] - Ø 450 [mm]

GEÇİŞ PARÇALARI - TRANSITION

RACCORDS DE TRANSITION / ПЕРЕХОДНЫЕ ФИТИНГИ / تركيبات إنتقالية
PE - PİRİNÇ GEÇİŞ - PE - BRASS TRANSITION PE - ÇELİK GEÇİŞ - PE - STEEL TRANSITION

Adaptateur De Transition Pe / Laiton, Raccord De Transition Pe / Acier
ПЭ / ЛАТУННЫЙ ПЕРЕХОДНИК, ПЭ / СТАЛЬНОЙ ПЕРЕХОДНИК

وصلة مرور من البولي إيثيلين / النحاس الأصفر قلووظ / الصلب

Ø 110 [mm] - Ø 500 [mm]

HDPE KREPİN - HDPE CREPINE FILTER

CRÉPINE PEHD / ФИЛЬТР ПЭ / مصفاة من البولي إيثيلين

Ø 110 [mm] - Ø 500 [mm]

BETON GEÇİŞ - CONCRETE TRANSITION

TRANSITION CONCRETE / ПЕРЕХОДНИК БЕТОН / انتقال ملموسة



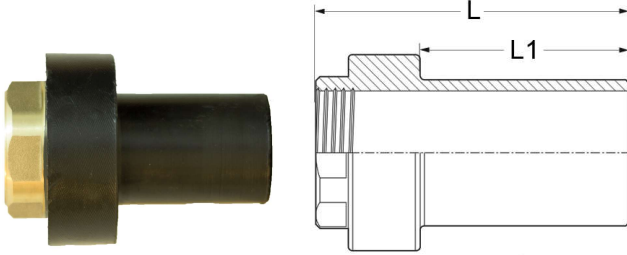

PRİNÇ GEÇİŞ (İÇ DİŞLİ)

PE-BRASS TRANSITION (FEMALE THREADED)
ADAPTATEUR DE TRANSITION PE / LAITON (FILETÉ FEMELLE)
ПЭ / ЛАТУННЫЙ ПЕРЕХОДНИК ВНУТРЕННЕЙ РЕЗЬБОЙ

وصلة مرور من البولي إيثيلين / النحاس الأصفر قلووظ داخلي

SIRA	ÜRÜN KODU	ÇAP d [mm]	L [mm]	L ₁ [mm]	AĞIRLIK [kg]	KOLİ ADEDİ	KOLİ EBATI
SEQ	PRODUCT CODE	SIZE d [mm]			WEIGHT [kg]	IN A PARCEL	PCS PRICE
1	97 7 443032	32/1	75,00	40,00	0,12	100	25/35/27
2	97 7 443432	32/¾	75,00	40,00	0,12	100	25/35/27
3	97 7 443040	40/1¼	80,00	45,00	0,24	50	25/35/27
4	97 7 443050	50/1½	90,00	60,00	0,34	40	25/35/27
5	97 7 443063	63/2	115,00	73,00	0,48	20	25/35/27
6	97 7 443075	75	130,00	90,00	0,68	12	25/35/27

water / gas

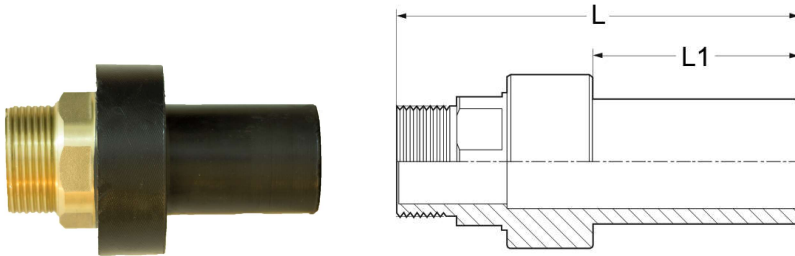

PRİNÇ GEÇİŞ (DİŞ DİŞLİ)

PE-BRASS TRANSITION (MALE THREADED)
ADAPTATEUR DE TRANSITION PE / LAITON (FILETÉ MÂLE)
ПЭ / ЛАТУННЫЙ ПЕРЕХОДНИК С НАРУЖНОЙ РЕЗЬБОЙ

وصلة مرور من البولي إيثيلين / النحاس الأصفر قلووظ خارجي

SIRA	ÜRÜN KODU	ÇAP d [mm]	L [mm]	L ₁ [mm]	AĞIRLIK [kg]	KOLİ ADEDİ	KOLİ EBATI
SEQ	PRODUCT CODE	SIZE d [mm]			WEIGHT [kg]	IN A PARCEL	PCS PRICE
1	97 7 433032	32/1	95,00	47,00	0,15	100	25/35/27
2	97 7 433432	32/¾	95,00	47,00	0,15	100	25/35/27
3	97 7 433040	40/1¼	95,00	47,00	0,25	50	25/35/27
4	97 7 433050	50/1½	110,00	57,00	0,53	40	25/35/27
5	97 7 433063	63/2	135,00	65,00	0,65	20	25/35/27
6	97 7 433075	75	150,00	100,00	0,81	12	25/35/27

"Yıldız bize, Biz Su'ya yön gösteriyoruz..."
"The stars show us the way, we show way to the water..."

www.yildizpolietilen.com

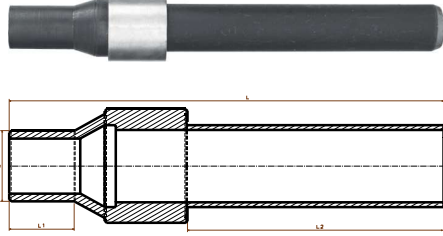

PE - ÇELİK GEÇİŞ (KAYNAK AĞIZLI)
PE - STEEL TRANSITION (WELDABLE)
TRANSITION PE / ACIER
ПЭ / СТАЛЬНОЙ ПЕРЕХОДНИК (СВАРНОЙ)
وصلة مرور من البولى إيثيلين / الصلب للحام

SIRA	ÜRÜN KODU	ÇAP d [mm]	L [mm]	L ₁ [mm]	L ₂ [mm]	AĞIRLIK [kg]	KOLİ ADEDİ	KOLİ EBATI
SEQ	PRODUCT CODE	SIZE d [mm]				WEIGHT [kg]	IN A PARCEL	PCS PRICE
1	97 6 412002	25/3/4"	250,00	140,00	40,00	0,39	80	23/35/26
2	97 6 412003	32/1"	310,00	160,00	55,00	0,71	24	23/35/26
3	97 6 412004	40/1 ^{1/4}	310,00	150,00	60,00	1,07	20	23/35/26
4	97 6 412005	50/1 ^{1/2}	310,00	150,00	60,00	1,44	16	23/35/26
5	97 6 412006	63/2"	405,00	200,00	90,00	1,84	25	41/60/46
6	97 6 412007	75/2 ^{1/2}	435,00	270,00	65,00	4,11	20	41/60/46
7	97 6 412009	90/3"	560,00	240,00	135,00	4,48	10	41/60/46
8	97 6 412011	110/4"	500,00	230,00	120,00	6,57	4	41/60/46
9	97 6 412012	125/4"	730,00	370,00	190,00	13,80	3	41/60/46
10	97 6 412016	160/6"	720,00	360,00	170,00	18,44	-	-
11	97 6 412020	200/8"	720,00	360,00	170,00	35,80	-	-
12	97 6 412022	225/8"	720,00	360,00	170,00	44,20	-	-
13	97 6 412025	250/10"	800,00	400,00	200,00	70,00	-	-
14	97 6 412028	280/10"	840,00	400,00	220,00	74,00	-	-
15	97 6 412031	315/12"	880,00	400,00	230,00	76,00	-	-
16	97 6 412035	355/14"	900,00	420,00	250,00	92,00	-	-
17	97 6 412040	400/16"	900,00	450,00	250,00	132,00	-	-
18	97 6 412045	450/18"	900,00	450,00	250,00	163,00	-	-

water / gas

PE - ÇELİK GEÇİŞ (MANŞONLU)
PE - STEEL TRANSITION (WITH COUPLE)

SIRA	ÜRÜN KODU	ÇAP d [mm]	L [mm]	L ₁ [mm]	L ₂ [mm]	AĞIRLIK [kg]	KOLİ ADEDİ	KOLİ EBATI
SEQ	PRODUCT CODE	SIZE d [mm]				WEIGHT [kg]	IN A PARCEL	PCS PRICE
1	97 6 412002	32/1"	365,00	165,00	35,00	0,69	24	23/35/26

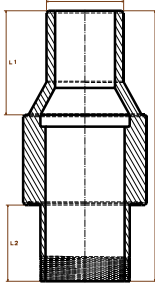

PE - ÇELİK GEÇİŞ (DIŞ DIŞLI)
PE - STEEL TRANSITION (MALE THREADED)
ADAPTATEUR DE TRANSITION PE / ACIER (FILETÉ MÂLE)
ПЭ / СТАЛЬНОЙ ПЕРЕХОДНИК С НАРУЖНОЙ РЕЗЬБОЙ

وصلة مرور من البولي إيثيلين / قلووظ خارجي

SIRA	ÜRÜN KODU	ÇAP d [mm]	L [mm]	L ₁ [mm]	L ₂ [mm]	AĞIRLIK [kg]	KOLİ ADEDİ	KOLİ EBATI
SEQ	PRODUCT CODE	SIZE d [mm]				WEIGHT [kg]		
1	97 2 430025	25	180,00	100,00	40,00	0,20	70	25/35/27
2	97 2 430032	32	170,00	72,00	34,00	0,72	55	25/35/27
3	97 2 430040	40	165,00	75,00	50,00	0,48	32	25/35/27
4	97 2 430050	50	170,00	72,00	34,00	0,72	15	25/35/27
5	97 2 430063	63	240,00	90,00	72,00	2,73	12	25/35/27
6	97 2 430075	75	240,00	90,00	72,00	2,73	6	25/35/27
7	97 2 430090	90	255,00	120,00	65,00	2,70	-	-
8	97 2 430110	110	320,00	75,00	130,00	3,40	-	-

water / gas

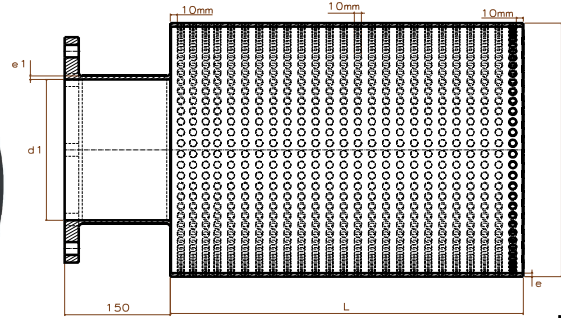
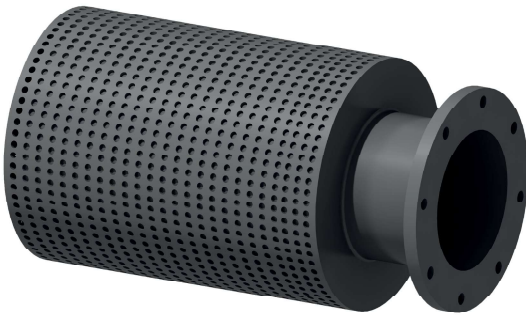

HDPE KREPİN
HDPE CREPINE FILTER

CRÉPINE PEHD / ФИЛЬТР ПЭ / مصفاة من البولي إيثيلين

SIRA	ÜRÜN KODU	ÇAP d1 [mm]	d [mm]	L [mm]	L ₁ [mm]	e [mm]	e ₁ [mm]	AĞIRLIK [kg]	KOLİ ADEDİ	KOLİ EBATI
SEQ	PRODUCT CODE	SIZE d1 [mm]						WEIGHT [kg]		
1	97 5 737110	110	200	250,00	145,00	5,00	4,50	0,79	-	-
2	97 5 737125	125	200	250,00	135,00	5,00	4,50	1,02	-	-
3	97 5 737140	140	200	250,00	127,50	5,00	4,50	1,27	-	-
4	97 5 737160	160	250	350,00	180,00	5,00	5,00	2,33	-	-
5	97 5 737180	180	250	350,00	195,00	5,00	5,00	2,95	-	-
6	97 5 737200	200	350	500,00	185,00	5,00	5,00	5,20	-	-
7	97 5 737225	225	350	500,00	200,00	5,00	5,00	6,55	-	-
8	97 5 737250	250	450	600,00	207,50	5,00	5,00	9,72	-	-
9	97 5 737280	280	450	600,00	195,00	5,00	5,00	12,18	-	-
10	97 5 737315	315	500	700,00	200,00	6,00	5,60	17,92	-	-
11	97 5 737355	355	600	800,00	217,50	6,00	6,30	26,00	-	-
12	97 5 737400	400	700	950,00	222,50	7,00	6,30	39,24	-	-
13	97 5 737500	500	850	1200,00	225,00	8,00	7,10	77,40	-	-

"Yıldız bize, Biz Su'ya yön gösteriyoruz..."
 "The stars show us the way, we show way to the water..."

www.yildizpolietilen.com - www.ypfittings.com

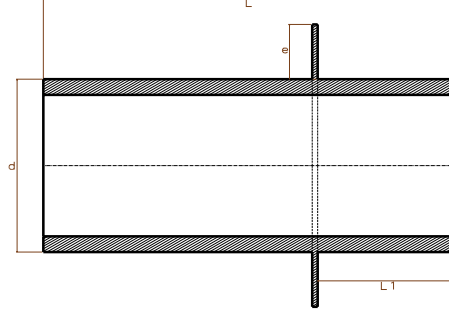
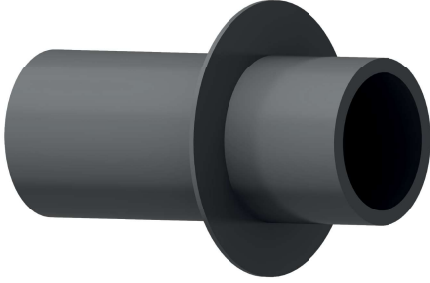

BETON GEÇİŞ CONCRETE TRANSITION

TRANSITION CONCRETE / ПЕРЕХОДНИК БЕТОН / انتقال ملموسة

SIRA	ÜRÜN KODU	ÇAP d [mm]	BASINÇ [bar]	L [mm]	L ₁ [mm]	e [mm]	e1 [mm]	AĞIRLIK [kg]	KOLİ ADEDİ	KOLİ EBATI
SEQ	PRODUCT CODE	SIZE d [mm]	PRESSURE [bar]	L [mm]	L ₁ [mm]	e [mm]	e1 [mm]	WEIGHT [kg]	IN A PARCEL	PCS PRICE
1	97 2 410110	110	PN10	750,00	250,00	100,00	6,60	1,63	-	-
	97 2 416110		PN16				10,00	2,36		
2	97 2 410125	125	PN10	750,00	250,00	100,00	7,40	2,06	-	-
	97 2 416125		PN16				11,40	3,06		
3	97 2 410140	140	PN10	750,00	250,00	100,00	8,30	2,60	-	-
	97 2 416140		PN16				12,70	3,81		
4	97 2 410160	160	PN10	750,00	250,00	100,00	9,50	3,39	-	-
	97 2 416160		PN16				14,60	5,00		
5	97 2 410180	180	PN10	750,00	250,00	100,00	10,70	4,28	-	-
	97 2 416180		PN16				16,40	6,32		
6	97 2 410200	200	PN10	750,00	250,00	100,00	11,90	5,29	-	-
	97 2 416200		PN16				18,20	7,80		
7	97 2 410225	225	PN10	750,00	250,00	100,00	13,40	6,70	-	-
	97 2 416225		PN16				20,50	9,83		
8	97 2 410250	250	PN10	750,00	250,00	100,00	14,80	8,25	-	-
	97 2 416250		PN16				22,70	12,15		
9	97 2 410280	280	PN10	750,00	250,00	100,00	16,60	10,28	-	-
	97 2 416280		PN16				25,40	15,23		
10	97 2 410315	315	PN10	750,00	250,00	100,00	18,70	13,05	-	-
	97 2 416315		PN16				28,60	19,20		
11	97 2 410355	355	PN10	750,00	250,00	100,00	21,10	16,58	-	-
	97 2 416355		PN16				32,20	24,38		
12	97 2 410400	400	PN10	750,00	250,00	100,00	23,70	21,00	-	-
	97 2 416400		PN16				36,30	30,98		
13	97 2 410500	500	PN10	750,00	250,00	100,00	26,70	26,55	-	-
	97 2 416500		PN16				40,90	39,23		

water / gas



YILDIZ
for the best
Polietilen

Ø 20 [mm] - Ø450 [mm]

PP KAPLI ÇELİK FLANŞ - PP COVERED STEEL FLANGE

BRIDE ACIER REVÊTUE PP / СТАЛЬНОЙ ФЛАНЕЦ С ПП ПОКРЫТИЕМ / فلانشة من الصلب مغطاة بالبولى بروبيلين

Ø 20 [mm] - Ø1600 [mm]

ÇELİK FLANŞ - STEEL FLANGE

BRIDE ACIER / СТАЛЬНОЙ ФЛАНЕЦ / فلانشة من الصلب



"Yıldız bize, Biz Su'ya yön gösteriyoruz..."
 "The stars show us the way, we show way to the water..."

www.yildizpolietilen.com

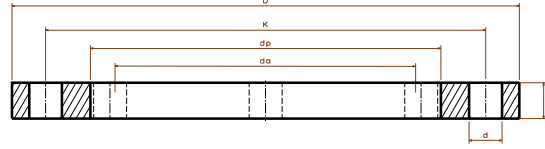

PP KAPLI ÇELİK FLANŞ PN 10
 PP COVERED STEEL FLANGE PN 10

BRIDE ACIER REVÊTUE PP / СТАЛЬНОЙ ФЛАНЕЦ С ПП ПОКРЫТИЕМ

فلانشة من الصلب مغطاة بالبولى بروبيلين

SIRA	ÜRÜN KODU	ÇELİK ANMA ÇAPI	PE ANMA ÇAPI	FLANŞ İÇ ÇAPI	DELİKLER ARASI MESAFE	FLANŞ DIŞ ÇAPI	DELİK ÇAPI	KALINLIK	DELİK SAYISI	AĞIRLIK [kg]
SEQ	PRODUCT CODE	SIZE OF STEEL dN [mm]	SIZE OF PE dN [mm]	FLANGE INNER DIA dp [mm]	DISTANCE BETWEEN HOLES K [mm]	FLANGE OUTER DIA D [mm]	HOLE DIA d[mm]	THICKNESS b [mm]	NUMBER OF HOLES n	WEIGHT [kg]
1	97 3 710020	15	20	28	65,00	95,00	14,00	14,00	4,00	0,10
2	97 3 710025	20	25	34	75,00	105,00	14,00	16,00	4,00	0,15
3	97 3 710032	25	32	42	85,00	115,00	14,00	16,00	4,00	0,41
4	97 3 710040	32	40	51	100,00	140,00	18,00	16,00	4,00	0,60
5	97 3 710050	40	50	62	110,00	150,00	18,00	16,00	4,00	0,66
6	97 3 710063	50	63	78	125,00	165,00	18,00	18,00	4,00	0,89
7	97 3 710075	65	75	92	145,00	185,00	18,00	18,00	4,00	1,07
8	97 3 710090	80	90	108	160,00	200,00	18,00	20,00	8,00	1,28
9	97 3 710110	100	110	125	180,00	220,00	18,00	20,00	8,00	1,37
10	97 3 710125	100	125	135	180,00	220,00	18,00	20,00	8,00	1,37
11	97 3 710140	125	140	158	210,00	250,00	18,00	22,00	8,00	1,91
12	97 3 710160	150	160	178	240,00	285,00	22,00	22,00	8,00	2,57
13	97 3 710180	150	180	188	240,00	285,00	22,00	22,00	8,00	2,34
14	97 3 710200	200	200	235	295,00	340,00	22,00	26,00	8,00	3,61
15	97 3 710225	200	225	238	295,00	340,00	22,00	26,00	8,00	3,61
16	97 3 710250	250	250	288	350,00	395,00	22,00	29,00	12,00	4,58
17	97 3 710280	250	280	294	350,00	395,00	22,00	29,00	12,00	4,21
18	97 3 710315	300	315	338	400,00	445,00	22,00	29,00	12,00	5,08
19	97 3 710355	350	355	-	-	-	-	-	-	-
20	97 3 710400	400	400	-	-	-	-	-	-	-
21	97 3 710450	450	450	-	-	-	-	-	-	-

water / gas

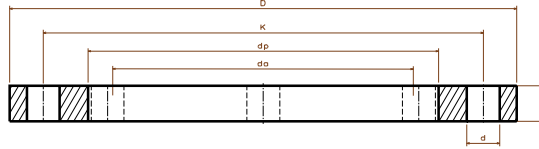

PP KAPLI ÇELİK FLANŞ PN 16
PP COVERED STEEL FLANGE PN 16
BRIDE ACIER REVÊTUE PP / СТАЛЬНОЙ ФЛАНЕЦ С ПП ПОКРЫТИЕМ

فلانشة من الصلب مغطاة بالبولى بروبيلين

water / gas

SIRA	ÜRÜN KODU	ÇELİK ANMA ÇAPI	PE ANMA ÇAPI	FLANŞ İÇ ÇAPI	DELİKLER ARASI MESAFE	FLANŞ DIŞ ÇAPI	DELİK ÇAPI	KALINLIK	DELİK SAYISI	AĞIRLIK [kg]
SEQ	PRODUCT CODE	SIZE OF STEEL dN [mm]	SIZE OF PE dN [mm]	FLANGE INNER DIA dp [mm]	DISTANCE BETWEEN HOLES K [mm]	FLANGE OUTER DIA D [mm]	HOLE DIA d [mm]	THICKNESS b [mm]	NUMBER OF HOLES n	WEIGHT [kg]
1	97 3 716020	15	20	28	65,00	95,00	14,00	14,00	4,00	0,10
2	97 3 716025	20	25	34	75,00	105,00	14,00	16,00	4,00	0,15
3	97 3 716032	25	32	42	85,00	115,00	14,00	16,00	4,00	0,41
4	97 3 716040	32	40	51	100,00	140,00	18,00	16,00	4,00	0,60
5	97 3 716050	40	50	62	110,00	150,00	18,00	16,00	4,00	0,66
6	97 3 716063	50	63	78	125,00	165,00	18,00	18,00	4,00	0,89
7	97 3 716075	65	75	92	145,00	185,00	18,00	18,00	4,00	1,07
8	97 3 716090	80	90	108	160,00	200,00	18,00	20,00	8,00	1,28
9	97 3 716110	100	110	125	180,00	220,00	18,00	20,00	8,00	1,37
10	97 3 716125	100	125	135	180,00	220,00	18,00	20,00	8,00	1,37
11	97 3 716140	125	140	158	210,00	250,00	18,00	22,00	8,00	1,91
12	97 3 716160	150	160	178	240,00	285,00	22,00	22,00	8,00	2,57
13	97 3 716180	150	180	188	240,00	285,00	22,00	22,00	8,00	2,34
14	97 3 716200	200	200	235	295,00	340,00	22,00	26,00	12,00	3,53
15	97 3 716225	200	225	235	295,00	340,00	22,00	26,00	12,00	3,53
16	97 3 716250	250	250	288	355,00	405,00	26,00	29,00	12,00	4,62
17	97 3 716280	250	280	294	355,00	405,00	26,00	29,00	12,00	4,67
18	97 3 716315	300	315	338	410,00	460,00	26,00	31,00	12,00	6,35
19	97 3 716355	350	355	-	-	-	-	-	-	-
20	97 3 716400	400	400	-	-	-	-	-	-	-
21	97 3 716450	450	450	-	-	-	-	-	-	-

"Yıldız bize, Biz Su'ya yön gösteriyoruz..."
 "The stars show us the way, we show way to the water..."

www.yildizpolietilen.com

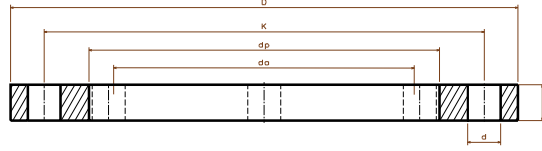

ÇELİK FLANŞ PN 10
 STEEL FLANGE PN 10

BRIDE ACIER / СТАЛЬНОЙ ФЛАНЕЦ / فلانشة من الصلب

SIRA	ÜRÜN KODU	ÇELİK ANMA ÇAPI	PE ANMA ÇAPI	FLANŞ İÇ ÇAPI	DELİKLER ARASI MESAFE	FLANŞ DIŞ ÇAPI	DELİK ÇAPI	KALINLIK	DELİK SAYISI	AĞIRLIK [kg]
SEQ.	PRODUCT CODE	SIZE OF STEEL dN [mm]	SIZE OF PE dN [mm]	FLANGE INNER DIA dp [mm]	DISTANCE BETWEEN HOLES K [mm]	FLANGE OUTER DIA D [mm]	HOLE DIA d [mm]	THICKNESS b [mm]	NUMBER OF HOLES n	WEIGHT [kg]
1	97 3 810020	15	20	28	65,00	95,00	14,00	14,00	4,00	0,65
2	97 3 810025	20	25	34	75,00	105,00	14,00	16,00	4,00	0,91
3	97 3 810032	25	32	42	85,00	115,00	14,00	16,00	4,00	1,06
4	97 3 810040	32	40	51	100,00	140,00	18,00	16,00	4,00	1,55
5	97 3 810050	40	50	62	110,00	150,00	18,00	16,00	4,00	1,72
6	97 3 810063	50	63	78	125,00	165,00	18,00	18,00	4,00	2,21
7	97 3 810075	65	75	92	145,00	185,00	18,00	18,00	4,00	2,72
8	97 3 810090	80	90	108	160,00	200,00	18,00	20,00	8,00	3,18
9	97 3 810110	100	110	125	180,00	220,00	18,00	20,00	8,00	3,73
10	97 3 810125	100	125	135	180,00	220,00	18,00	20,00	8,00	3,41
11	97 3 810140	125	140	158	210,00	250,00	18,00	22,00	8,00	4,75
12	97 3 810160	150	160	178	240,00	285,00	22,00	22,00	8,00	6,21
13	97 3 810180	150	180	188	240,00	285,00	22,00	22,00	8,00	5,71
14	97 3 810200	200	200	235	295,00	340,00	22,00	24,00	8,00	8,38
15	97 3 810225	200	225	238	295,00	340,00	22,00	24,00	8,00	8,17
16	97 3 810250	250	250	288	350,00	395,00	22,00	26,00	12,00	10,81
17	97 3 810280	250	280	294	350,00	395,00	22,00	26,00	12,00	10,25
18	97 3 810315	300	315	338	400,00	445,00	22,00	26,00	12,00	12,53
19	97 3 810355	350	355	376	460,00	505,00	22,00	26,00	16,00	17,02
20	97 3 810400	400	400	430	515,00	565,00	26,00	26,00	16,00	19,85
21	97 3 810450	450	450	465	565,00	615,00	26,00	28,00	20,00	25,69
22	97 3 810500	500	500	533	620,00	670,00	26,00	28,00	20,00	26,18
23	97 3 810560	600	560	618	725,00	780,00	30,00	28,00	20,00	36,07
24	97 3 810630	600	630	645	725,00	780,00	30,00	28,00	20,00	30,17
25	97 3 810710	700	710	740	840,00	895,00	30,00	30,00	24,00	42,98
26	97 3 810800	800	800	843	950,00	1015,00	33,00	32,00	24,00	58,03
27	97 3 810900	900	900	947	1050,00	1115,00	33,00	34,00	28,00	66,38
28	97 3 810990	1000	1000	1050	1160,00	1230,00	36,00	34,00	28,00	78,61
29	97 3 810992	1200	1200	1250	1380,00	1455,00	39,00	38,00	32,00	118,79
30	97 3 810994	1400	1400	1460	1590,00	1675,00	42,00	42,00	36,00	158,47
31	97 3 810996	1600	1600	1650	1820,00	1915,00	48,00	46,00	40,00	242,37

water / gas

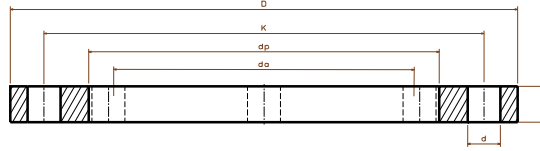

ÇELİK FLANŞ PN 16

STEEL FLANGE PN 16

BRIDE ACIER / СТАЛЬНОЙ ФЛАНЕЦ / فلانشة من الصلب

SIRA	ÜRÜN KODU	ÇELİK ANMA ÇAPI	PE ANMA ÇAPI	FLANŞ İÇ ÇAPI	DELİKLER ARASI MESAFE	FLANŞ DIŞ ÇAPI	DELİK ÇAPI	KALINLIK	DELİK SAYISI	AĞIRLIK [kg]
SEQ	PRODUCT CODE	SIZE OF STEEL dN [mm]	SIZE OF PE dN [mm]	FLANGE INNER DIA dp [mm]	DISTANCE BETWEEN HOLES K [mm]	FLANGE OUTER DIA D [mm]	HOLE DIA d [mm]	THICKNESS b [mm]	NUMBER OF HOLES n	WEIGHT [kg]
1	97 3 816020	15	20	28	65,00	95,00	14,00	14,00	4,00	0,65
2	97 3 816025	20	25	34	75,00	105,00	14,00	16,00	4,00	0,91
3	97 3 816032	25	32	42	85,00	115,00	14,00	16,00	4,00	1,06
4	97 3 816040	32	40	51	100,00	140,00	18,00	16,00	4,00	1,55
5	97 3 816050	40	50	62	110,00	150,00	18,00	16,00	4,00	1,72
6	97 3 816063	50	63	78	125,00	165,00	18,00	18,00	4,00	2,21
7	97 3 816075	65	75	92	145,00	185,00	18,00	18,00	4,00	2,72
8	97 3 816090	80	90	108	160,00	200,00	18,00	20,00	8,00	3,18
9	97 3 816110	100	110	125	180,00	220,00	18,00	20,00	8,00	3,73
10	97 3 816125	100	125	135	180,00	220,00	18,00	20,00	8,00	3,41
11	97 3 816140	125	140	158	210,00	250,00	18,00	22,00	8,00	4,75
12	97 3 816160	150	160	178	240,00	285,00	22,00	22,00	8,00	6,21
13	97 3 816180	150	180	188	240,00	285,00	22,00	22,00	8,00	5,71
14	97 3 816200	200	200	235	295,00	340,00	22,00	24,00	12,00	8,09
15	97 3 816225	200	225	238	295,00	340,00	22,00	24,00	12,00	7,88
16	97 3 816250	250	250	288	355,00	405,00	26,00	26,00	12,00	11,72
17	97 3 816280	250	280	294	355,00	405,00	26,00	26,00	12,00	11,16
18	97 3 816315	300	315	338	410,00	460,00	26,00	28,00	12,00	15,44
19	97 3 816355	350	355	376	470,00	520,00	26,00	30,00	16,00	21,92
20	97 3 816400	400	400	430	525,00	580,00	30,00	32,00	16,00	27,11
21	97 3 816450	450	450	465	585,00	640,00	30,00	34,00	20,00	36,85
22	97 3 816500	500	500	533	650,00	715,00	33,00	34,00	20,00	43,15
23	97 3 816560	600	560	618	770,00	840,00	36,00	36,00	20,00	66,24
24	97 3 816630	600	630	645	770,00	840,00	36,00	36,00	20,00	58,66
25	97 3 816710	700	710	740	840,00	910,00	36,00	36,00	24,00	55,49
26	97 3 816800	800	800	843	950,00	1025,00	39,00	38,00	24,00	71,27
27	97 3 816900	900	900	947	1050,00	1125,00	39,00	40,00	28,00	80,64
28	97 3 816990	1000	1000	1050	1170,00	1255,00	42,00	42,00	28,00	110,00
29	97 3 816992	1200	1200	1250	1390,00	1485,00	48,00	48,00	32,00	169,00
30	97 3 816994	1400	1400	1460	1590,00	1685,00	48,00	52,00	36,00	201,00
31	97 3 816996	1600	1600	1650	1820,00	1930,00	56,00	58,00	40,00	316,00

water / gas

"Yıldız bize, Biz Su'ya yön gösteriyoruz..."
"The stars show us the way, we show way to the water..."

www.yildizpolietilen.com

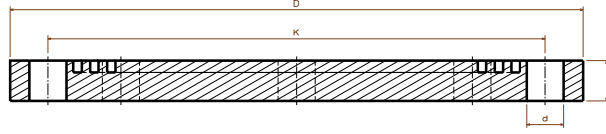

ÇELİK KÖR FLANŞ PN 10
STEEL BLIND FLANGE PN 10

BRIDE PLEINE EN ACIER / СТАЛЬНОЙ ГЛУХОЙ ФЛАНЕЦ / فلانشة من الصلب عمياء

SIRA	ÜRÜN KODU	ÇELİK ANMA ÇAPI	PE ANMA ÇAPI	DELİKLER ARASI MESAFE	FLANŞ DIŞ ÇAPI	DELİK ÇAPI	KALINLIK	DELİK SAYISI	AĞIRLIK [kg]
SEQ	PRODUCT CODE	SIZE OF STEEL dN [mm]	SIZE OF PE dN [mm]	DISTANCE BETWEEN HOLES K [mm]	FLANGE OUTER DIA D [mm]	HOLE DIA d[mm]	THICKNESS b [mm]	NUMBER OF HOLES n	WEIGHT [kg]
1	97 3 510020	15	20	65,00	95,00	14,00	14,00	4,00	0,71
2	97 3 510025	20	25	75,00	105,00	14,00	16,00	4,00	1,01
3	97 3 510032	25	32	85,00	115,00	14,00	16,00	4,00	1,23
4	97 3 510040	32	40	100,00	140,00	18,00	16,00	4,00	1,81
5	97 3 510050	40	50	110,00	150,00	18,00	16,00	4,00	2,10
6	97 3 510063	50	63	125,00	165,00	18,00	18,00	4,00	2,88
7	97 3 510075	65	75	145,00	185,00	18,00	18,00	4,00	3,66
8	97 3 510090	80	90	160,00	200,00	18,00	20,00	8,00	4,62
9	97 3 510110	100	110	180,00	220,00	18,00	20,00	8,00	5,66
10	97 3 510125	100	125	180,00	220,00	18,00	20,00	8,00	5,66
11	97 3 510140	125	140	210,00	250,00	18,00	22,00	8,00	8,15
12	97 3 510160	150	160	240,00	285,00	22,00	22,00	8,00	10,52
13	97 3 510180	150	180	240,00	285,00	22,00	22,00	8,00	10,52
14	97 3 510200	200	200	295,00	340,00	22,00	24,00	8,00	16,57
15	97 3 510225	200	225	295,00	340,00	22,00	24,00	8,00	16,57
16	97 3 510250	250	250	350,00	395,00	22,00	26,00	12,00	24,14
17	97 3 510280	250	280	350,00	395,00	22,00	26,00	12,00	24,14
18	97 3 510315	300	315	400,00	445,00	22,00	26,00	12,00	30,89
19	97 3 510355	350	355	460,00	505,00	22,00	26,00	16,00	39,73
20	97 3 510400	400	400	515,00	565,00	26,00	26,00	16,00	49,56
21	97 3 510450	450	450	565,00	615,00	26,00	28,00	20,00	63,11
22	97 3 510500	500	500	620,00	670,00	26,00	28,00	20,00	75,34
23	97 3 510560	600	560	725,00	780,00	30,00	28,00	20,00	102,16
24	97 3 510630	600	630	725,00	780,00	30,00	28,00	20,00	102,16
25	97 3 510710	700	710	840,00	895,00	30,00	30,00	24,00	144,51
26	97 3 510800	800	800	950,00	1015,00	33,00	32,00	24,00	198,57
27	97 3 510900	900	900	1050,00	1115,00	33,00	34,00	28,00	254,82
28	97 3 510990	1000	1000	1150,00	1200,00	36,00	34,00	28,00	310,26
29	97 3 510992	1200	1200	1380,00	1455,00	39,00	38,00	32,00	485,73
30	97 3 510994	1400	1400	1590,00	1675,00	42,00	42,00	36,00	711,74
31	97 3 510996	1600	1600	1820,00	1915,00	48,00	46,00	40,00	1016,31

water / gas

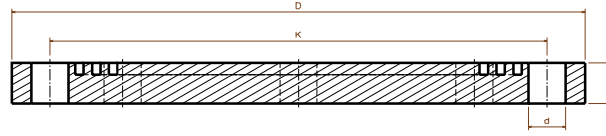

ÇELİK KÖR FLANŞ PN 16
STEEL BLIND FLANGE PN 16

BRIDE PLEINE EN ACIER / СТАЛЬНОЙ ГЛУХОЙ ФЛАНЕЦ / فلاشة من الصلب عمياء

SIRA	ÜRÜN KODU	ÇELİK ANMA ÇAPI	PE ANMA ÇAPI	DELİKLER ARASI MESAFE	FLANŞ DIŞ ÇAPI	DELİK ÇAPI	KALINLIK	DELİK SAYISI	AĞIRLIK [kg]
SEQ	PRODUCT CODE	SIZE OF STEEL dN [mm]	SIZE OF PE dN [mm]	DISTANCE BETWEEN HOLES K [mm]	FLANGE OUTER DIA D [mm]	HOLE DIA d[mm]	THICKNESS b [mm]	NUMBER OF HOLES n	WEIGHT [kg]
1	97 3 516020	15	20	65,00	95,00	14,00	14,00	4,00	0,71
2	97 3 516025	20	25	75,00	105,00	14,00	16,00	4,00	1,01
3	97 3 516032	25	32	85,00	115,00	14,00	16,00	4,00	1,23
4	97 3 516040	32	40	100,00	140,00	18,00	16,00	4,00	1,81
5	97 3 516050	40	50	110,00	150,00	18,00	16,00	4,00	2,10
6	97 3 516063	50	63	125,00	165,00	18,00	18,00	4,00	2,88
7	97 3 516075	65	75	145,00	185,00	18,00	18,00	4,00	3,66
8	97 3 516090	80	90	160,00	200,00	18,00	20,00	8,00	4,62
9	97 3 516110	100	110	180,00	220,00	18,00	20,00	8,00	5,66
10	97 3 516125	100	125	180,00	220,00	18,00	20,00	8,00	5,66
11	97 3 516140	125	140	210,00	250,00	18,00	22,00	8,00	8,15
12	97 3 516160	150	160	240,00	285,00	22,00	22,00	8,00	10,52
13	97 3 516180	150	180	240,00	285,00	22,00	22,00	8,00	10,52
14	97 3 516200	200	200	295,00	340,00	22,00	24,00	12,00	16,28
15	97 3 516225	200	225	295,00	340,00	22,00	24,00	12,00	16,28
16	97 3 516250	250	250	355,00	405,00	26,00	26,00	12,00	25,05
17	97 3 516280	250	280	355,00	405,00	26,00	26,00	12,00	25,05
18	97 3 516315	300	315	410,00	460,00	26,00	28,00	12,00	35,21
19	97 3 516355	350	355	470,00	520,00	26,00	30,00	16,00	48,13
20	97 3 516400	400	400	525,00	580,00	30,00	32,00	16,00	63,68
21	97 3 516450	450	450	585,00	640,00	30,00	34,00	20,00	82,28
22	97 3 516500	500	500	650,00	715,00	33,00	34,00	20,00	102,84
23	97 3 516560	600	560	770,00	840,00	36,00	36,00	20,00	151,22
24	97 3 516630	600	630	770,00	840,00	36,00	36,00	20,00	151,22
25	97 3 516710	700	710	840,00	910,00	36,00	36,00	24,00	177,32
26	97 3 516800	800	800	950,00	1025,00	39,00	38,00	24,00	238,16
27	97 3 516900	900	900	1050,00	1125,00	39,00	40,00	28,00	302,33
28	97 3 516990	1000	1000	1170,00	1255,00	42,00	42,00	28,00	395,99
29	97 3 516992	1200	1200	1390,00	1485,00	48,00	48,00	32,00	632,29
30	97 3 516994	1400	1400	1590,00	1685,00	48,00	52,00	36,00	885,76
31	97 3 516996	1600	1600	1820,00	1930,00	56,00	58,00	40,00	1291,78

water / gas

YILDIZ POLİETİLEN

İML. İTH. İHR. SAN. TİC. LTD. ŞTİ.

Merkez Ofis / Office / Siège Social / ГЛАВНЫЙ ОФИС / المقر الرئيسي :

İvedik Org. San. Böl. (Industrial Zone) 1444. Cadde (Street,) No: 1 Ostim / Ankara - Turkey

Tel: +90 312 394 07 58 - +90 312 394 15 27 Fax: +90 312 394 07 59

Fabrika / Factory / Usine / ЗАВОД / المصنع :

Kırıkkale Org. San. Böl. (Industrial Zone) Kızılırmak Cad. (Road,) 1. Sok. (Street,) No:13

Yahsihan / Kırıkkale - Turkey

Tel: +90 318 321 33 34 - +90 318 321 33 35 Fax: +90 318 321 33 36

www.yildizpolietilen.com